

TECHNICAL MANUAL

AF TECHNICAL ORDER SYSTEM

(ATOS-HILL)

THIS PUBLICATION SUPERSEDES TO 00-5-1, DATED 1 OCTOBER 2014.

FOR QUESTIONS CONCERNING TECHNICAL CONTENT OF THIS TECHNICAL MANUAL, CONTACT THE APPLICABLE TECHNICAL CONTENT MANAGER (TCM) LISTED IN THE ENHANCED TECHNICAL INFORMATION MANAGEMENT SYSTEM (ETIMS). HQ AFMC/A4FI, WPAFB, OH IS THE APPROVAL AND WAIVER AUTHORITY FOR THIS TECHNICAL MANUAL.

DISTRIBUTION STATEMENT A: Approved for public release; distribution is unlimited. HQ AFMC PA Case Number 04-318. Submit recommended changes or problems with this technical order to the applicable TO Manager (TM) listed in ETIMS using the Recommended Change Process outlined in Chapter 9 of this Technical Order.

LIST OF EFFECTIVE PAGES

NOTE: The portion of the text affected by the changes is indicated by a vertical line in the outer margins of the page. Changes to illustrations are indicated by shaded or screened areas, or by miniature pointing hands.

Dates of issue for original and changed pages are:

Original..... 0 14 June 2016

TOTAL NUMBER OF PAGES IN THIS MANUAL IS 148, CONSISTING OF THE FOLLOWING:

Page No.	*Change No.	Page No.	*Change No.	Page No.	*Change No.
Title	0				
A	0				
i - ix	0				
x Blank	0				
1-1 - 1-3	0				
1-4 Blank	0				
2-1 - 2-35	0				
2-36 Blank	0				
3-1 - 3-2	0				
4-1 - 4-10	0				
5-1 - 5-14	0				
6-1 - 6-7	0				
6-8 Blank	0				
7-1 - 7-4	0				
8-1 - 8-5	0				
8-6 Blank	0				
9-1 - 9-9	0				
9-10 Blank	0				
10-1 - 10-9	0				
10-10 Blank	0				
11-1	0				
11-2 Blank	0				
A-1 - A-15	0				
A-16 Blank	0				
B-1 - B-4	0				
C-1 - C-3	0				
C-4 Blank	0				
D-1 - D-2	0				
E-1 - E-3	0				
E-4 Blank	0				

*Zero in this column indicates an original page

TABLE OF CONTENTS

Chapter	Page
FOREWORD	ix
1 INTRODUCTION, SCOPE AND EXCLUSIONS.....	1-1
1.1 Introduction.....	1-1
1.2 Scope.....	1-1
1.3 TO Precedence.....	1-1
1.4 Exclusions.....	1-2
1.5 Air Force Technical Order Use	1-3
2 TECHNICAL ORDER (TO) TYPES, SUPPORT DATA, UPDATES AND FRONT MATTER.....	2-1
SECTION I TYPES OF TECHNICAL ORDERS.....	2-1
2.1 Operations & Maintenance (O&M) Technical Orders.....	2-1
2.1.1 Flight Manual Program (FMP) Publications	2-1
2.1.2 On-Equipment Organizational Maintenance Manual Sets	2-1
2.1.3 Nuclear Weapons Manuals.....	2-1
2.1.4 Nonnuclear Weapons Delivery Manuals	2-1
2.1.5 Aircraft Emergency Rescue Information	2-1
2.1.6 Communications-Electronics Manuals.....	2-1
2.1.7 Work Package TOs.....	2-1
2.1.8 Calibration TOs	2-1
2.1.9 Computer-Related Manuals.....	2-2
2.2 General, Methods and Procedures Technical Orders	2-2
2.2.1 General TOs.....	2-2
2.2.2 Methods and Procedures TOs (MPTOs)	2-2
2.3 Index Technical Orders	2-2
2.3.1 TO Catalog	2-2
2.3.2 Special TO Indexes	2-2
2.3.3 Enhanced Technical Information Management System (ETIMS) Table of Contents (TOC) TO.....	2-2
2.3.4 Lists of Applicable Publications (LOAP).....	2-2
2.4 Abbreviated Technical Orders	2-2
2.4.1 Inspection Workcards.....	2-2
2.4.2 Inspection Sequence Charts	2-2
2.4.3 Checklists.....	2-3
2.5 Brief Manuals	2-3
2.6 Time Compliance Technical Orders (TCTO).....	2-3
2.7 Supplemental Manual Technical Orders.....	2-3
2.8 Joint-Use Publications	2-3
2.9 Commercial Off-The-Shelf (COTS) Manuals	2-3
SECTION II SUPPORT DATA	2-4
2.10 Service Bulletins, Operations Manual Bulletins, FAA Airworthiness Directives, Temporary Re- visions, And Like Data.....	2-4
2.11 Contractor Data.....	2-4
2.12 Other Authorized Support Data	2-4
2.12.1 Source Data.....	2-4
2.12.2 Engineering Drawings	2-4
2.12.3 Locally Prepared Workcards, Checklists, Job Guides and Page Supplements	2-4
2.12.4 Other Data.....	2-5

2.13	Preliminary Technical Orders (PTO).....	2-5
SECTION III TECHNICAL ORDER UPDATES		2-6
2.14	Difference Data Sheets.....	2-6
2.15	Technical Order Revisions	2-6
2.16	Technical Order Changes	2-6
2.16.1	Added Pages	2-7
2.16.2	Change Page Marking	2-7
2.16.3	Rapid Action Changes (RACs).....	2-7
2.17	Technical Order Supplements	2-7
2.17.1	General.....	2-7
2.17.2	Formal Supplements.....	2-8
2.17.3	TO Page Supplements (TOPS)	2-8
2.17.4	Interim Operational and Safety Supplements (IOS/ISS) (Figure 2-16, Figure 2-17 and Figure 2-18)	2-9
2.17.5	Identifying Technical Publications Sheets (ITPS).....	2-10
2.18	MAJCOM, Base and Unit Technical Order Supplements	2-11
2.18.1	MAJCOM Supplements	2-11
2.18.2	MAJCOM Supplements to Aircraft or Missile Inventory (-21) TOs.....	2-11
SECTION IV TECHNICAL ORDER FRONT MATTER CONTENT		2-11
2.19	Title Pages	2-11
2.19.1	Disclosure Notice	2-12
2.19.2	Distribution Statement	2-12
2.19.3	Export Control Warning Label	2-12
2.19.4	Disposition/Handling and Destruction Notice	2-12
2.20	Abbreviated Title Pages	2-12
2.21	List of Effective Pages (LEP).....	2-12
2.22	Verification Status Pages (VSP).....	2-12
3	AIR FORCE STANDARD TECHNICAL ORDER MANAGEMENT SYSTEM.....	3-1
3.1	Introduction.....	3-1
3.2	Enhanced Technical Information Management System (ETIMS).....	3-1
3.2.1	TO Catalog	3-1
3.2.2	Accounts	3-1
3.2.3	Orders.....	3-2
3.2.4	Review	3-2
3.2.5	Reports	3-2
3.2.6	My libs.....	3-2
3.2.7	My TOs.....	3-2
3.2.8	My eTools.....	3-2
3.2.9	TO Viewer.....	3-2
3.2.10	Data Discrepancy Reports (DDR)	3-2
3.2.11	ETIMS Training	3-2
3.3	Technical Order Catalogs.....	3-2
3.4	Air Force Technical Order Archive.....	3-2
4	ESTABLISHING AND MANAGING TECHNICAL ORDER DISTRIBUTION OFFICES (TODO) AND ACCOUNTS (TODA)	4-1
4.1	Introduction.....	4-1
4.1.5	TODO Outlook Mailboxes.....	4-1
4.1.6	E-Mail Notification.....	4-2
4.2	Establishing TODOs.....	4-2
4.2.1	Security Assistance Program (SAP) TODOs	4-2
4.2.2	COCO TODOs	4-2
4.2.3	GOCO TODOs	4-2

4.2.4	Standard TODOs	4-3
4.2.5	Nuclear Weapons and Nuclear Related EOD TODOs.....	4-3
4.2.6	Nonnuclear EOD TODOs	4-3
4.3	Actions Following TODO Establishment.....	4-3
4.3.1	AFLCMC/LZPTP-Tinker SO Actions.....	4-3
4.3.2	CPIN Account Establishment.....	4-3
4.3.3	TODO Actions.....	4-3
4.4	TODO Functions	4-4
4.4.3	MAJCOM and Base TODO Accounts	4-5
4.4.4	Functional System Administrator (FSA) Responsibilities for eTools and Commercial Mobile Devices (CMDs).....	4-6
4.5	TODA Functions	4-6
4.6	Library Custodian Functions.....	4-7
4.7	MAJCOM and Base eTool Group Administrator Functions	4-7
4.8	TODO, TODA and Library Custodian Checklist.....	4-7
5	ESTABLISHING AND MANAGING TECHNICAL ORDER LIBRARIES.....	5-1
5.1	Physical Media Technical Order Libraries.....	5-1
5.1.1	Operational Libraries.....	5-1
5.1.2	Aircraft Emergency Operating Instructions Libraries.....	5-1
5.1.3	Aircraft Libraries	5-1
5.1.4	Transient Aircraft Library	5-2
5.1.5	Reference Libraries.....	5-2
5.1.6	Training Libraries	5-2
5.1.7	Contractor Libraries.....	5-2
5.1.8	Rescinded Copies Libraries.....	5-2
5.1.9	Reclamation Removal Work Package Library	5-2
5.1.10	Work Package Libraries.....	5-2
5.2	Technical Orders Assigned to Individuals.....	5-2
5.3	Technical Order Access Control.....	5-3
5.3.1	General.....	5-3
5.3.2	Physical Distribution Media TOs.....	5-3
5.3.3	ETIMS eTOs.....	5-3
5.3.4	Digital TO Files (other than ETIMS eTOs).....	5-3
5.4	Contractor Access to USAF Technical Order Libraries	5-3
5.5	Filing Physical Distribution TOs and Use of Binders	5-4
5.5.1	General.....	5-4
5.5.2	Labels and Markings	5-4
5.5.3	TO Sets	5-4
5.5.4	Unit Filing Methods	5-4
5.5.5	Renumbered TOs.....	5-4
5.5.6	Commercial Publications.....	5-5
5.5.7	Preliminary TOs (PTOs)	5-5
5.5.8	Preliminary COTS Manuals (paragraph 2.9).....	5-5
5.5.9	Digital TOs	5-5
5.5.10	Interfiling Prohibition.....	5-5
5.5.11	Local Page Supplement Front Matter.....	5-5
5.5.12	Other DoD Component Technical Manuals	5-5
5.5.13	Non-TO Documents	5-5
5.6	Posting Technical Order Updates	5-5
5.6.1	Authorized Updates	5-5
5.6.2	Supersedure Notices	5-5
5.6.3	Foldout Pages	5-5
5.6.4	Formal and Interim TO Supplements	5-5
5.6.5	LEP Checks	5-6
5.6.6	Posting Time Limits	5-6
5.6.7	Updating e-Tools	5-6
5.6.8	Posting Revisions	5-7
5.6.9	Posting TO Changes.....	5-7

5.6.10	Appendixes	5-8
5.6.11	Supplements to Other Services TMs	5-8
5.6.12	Changes to Other Services' Publications.....	5-8
5.6.13	Posting RACs	5-8
5.6.14	Posting Supplements.....	5-8
5.6.15	Posting TOPS	5-9
5.6.16	Annotating Supplements (Paper Copies Only).....	5-9
5.6.17	Posting ITPS	5-9
5.6.18	Posting Priority Updates for TOs on CD-ROMs	5-10
5.6.19	Posting TCTOs	5-10
5.6.20	Highlighting Prohibition.....	5-10
5.7	Posting MAJCOM, Base and Unit Supplements	5-10
5.7.1	Posting by ANG Units	5-10
5.7.2	MAJCOM, Base and Unit Supplements to Digital TOs.....	5-10
5.7.3	Posting MAJCOM, Base and Unit Supplements to Paper TOs	5-10
5.8	Checking Technical Order Account Distribution Records and Libraries.....	5-10
5.8.1	Weekly Checks.....	5-10
5.8.2	Annual Checks.....	5-11
5.8.3	List of Effective Pages (LEP) Checks.....	5-11
5.9	Rescission and Reinstatement/Reactivation of Technical Orders	5-12
5.10	Disposition of Technical Orders and Forms	5-12
6	ORDERING TECHNICAL ORDERS	6-1
6.1	General	6-1
6.1.1	Determining TO Requirements	6-1
6.1.2	Sponsor Approval TOs.....	6-1
6.2	Establishing Subscriptions.....	6-2
6.2.1	General.....	6-2
6.2.2	Unpublished TOs.....	6-2
6.2.3	Physical Media TOs	6-2
6.2.4	Classified or Restricted TCTOs	6-2
6.2.5	Preliminary TOs (PTOs)	6-2
6.2.6	Rescinded or Superseded TOs and TO Increments	6-2
6.2.7	Renumbered TOs.....	6-3
6.2.8	Reclassified TOs.....	6-3
6.2.9	Reinstated/Reactivated TOs	6-3
6.2.10	Interim Technical Orders (ITO) and RACs.....	6-3
6.2.11	ETIMS TO Update Follow-up	6-3
6.3	Requisitions.....	6-3
6.3.1	Emergencies.....	6-3
6.3.2	Preliminary TOs	6-4
6.3.3	Interim TOs.....	6-4
6.3.4	FOIA	6-4
6.3.5	Inactive TOs	6-4
6.3.6	ETIMS One-Time Requisition Follow-up	6-4
6.3.7	One-Time Requisition of Fleet Vehicle Manuals	6-4
6.4	Contractor Requirements	6-5
6.4.1	TOs Required for Support of Government Weapons Systems Acquisition Contracts	6-5
6.4.2	Foreign Contractors Supporting U.S. Program Offices	6-5
6.4.3	Requests Related to Procurement and Competition Advocacy Announcements	6-5
6.5	Non-Releasable USAF Technical Orders for Direct Contractor Support of an FMS Program	6-6
6.5.1	Security Assistance Program (SAP)/Foreign Military Sales (FMS) Customers	6-6
6.5.2	TO Requests from Foreign Companies and Individuals.....	6-6
6.5.3	TOs to Support Non-USAF-Managed FMS Contracts and Direct Sales Programs with Follow-on FMS Contracts	6-6
6.6	Other Requests.....	6-6
6.6.1	Public Releasable TOs	6-6
6.6.2	Other Government Agencies Need for TOs.....	6-6
6.6.3	FOIA Request.....	6-6

6.6.4	Commercial Manual Request.....	6-7
7	DISTRIBUTING AND LOCALLY REPRODUCING TECHNICAL ORDERS.....	7-1
7.1	Technical Order Dissemination Control.....	7-1
7.1.1	Distribution Control Notices.....	7-1
7.1.2	Disclosure Notices.....	7-1
7.1.3	Export Control Warning.....	7-1
7.1.4	Disposition and/or Destruction Notice.....	7-1
7.1.5	Security Classification.....	7-1
7.1.6	For Official Use Only (FOUO).....	7-1
7.1.7	Controlling Distribution of Technical Orders.....	7-1
7.2	Technical Order Shipments.....	7-2
7.2.1	Initial Distribution (ID).....	7-2
7.2.2	ID Mailing Methods.....	7-2
7.2.3	Classified TO Packaging.....	7-2
7.2.4	Multiple Package Shipments.....	7-2
7.2.5	Receipt of Secret or Classified TOs.....	7-2
7.2.6	Suspected Lost Classified TO Shipments.....	7-2
7.2.7	Export-Controlled TO Shipments.....	7-2
7.2.8	Remote Units.....	7-2
7.2.9	Deploying Units.....	7-2
7.2.10	Release of TOs in Support of Litigation.....	7-2
7.2.11	TO 00-105E-9, Aerospace Emergency Rescue and Mishap Response Information (Emergency Services), Distribution to Civilian Fire Departments.....	7-2
7.2.12	Replacement Pages.....	7-3
7.2.13	Reporting Packaging and Shipping Problems.....	7-3
7.2.14	Reporting TO Print Quality Problems.....	7-3
7.3	Actions Required Upon Receipt of TO Shipments.....	7-3
7.4	Receipt of Interim Technical Orders (ITO) and Rapid Action Changes (RAC).....	7-3
7.5	Receipt of Formal Time Compliance Technical Orders (TCTO).....	7-4
7.6	Local Printing and Reproduction of Paper Media Technical Orders.....	7-4
8	CROSS-SERVICE UTILIZATION OF TECHNICAL PUBLICATIONS.....	8-1
8.1	General.....	8-1
8.2	Obtaining Army Publications and Related Forms.....	8-1
8.2.1	Army Technical Manual (TM) Accounts.....	8-1
8.2.2	Subscriptions.....	8-1
8.2.3	Procedures to Requisition Army TMs.....	8-1
8.2.4	References.....	8-3
8.2.5	Procedures for Other Components to Recommend Changes to Army Single-use TMs.....	8-3
8.2.6	Army Points of Contact (POCs).....	8-3
8.3	Obtaining Navy Publications.....	8-5
8.3.1	Establishing Subscriptions.....	8-5
8.3.2	Requisitioning TMs.....	8-5
8.4	Obtaining Marine Corps Publications.....	8-5
8.5	Technical Orders for Non-DoD Government Activities.....	8-5
9	RECOMMENDING CHANGES TO TECHNICAL ORDERS.....	9-1
9.1	General.....	9-1
9.1.1	TO Updates.....	9-1
9.1.2	Technical Assistance.....	9-1
9.1.3	New TO Types.....	9-1
9.1.4	Flight Manuals Program Publications.....	9-1
9.1.5	Work Unit Code (WUC) Manuals.....	9-1
9.1.6	Deficiency Reports.....	9-1
9.1.7	Calibration Responsibility Determinations (AFTO Form 45, Request for Calibration Responsibility Determination).....	9-1

9.1.8	Acquisition and PTOs	9-1
9.1.9	Support Equipment Requirements	9-1
9.1.10	Contractor Data.....	9-1
9.1.11	Classified Recommendations	9-1
9.1.12	Airmen Powered by Innovation Program (API)	9-2
9.1.13	Using AFTO Form 22 to Process Recommended Changes	9-2
9.1.14	Mishap Investigation Directed Changes	9-2
9.1.15	Submitting Changes to Joint-Use TMs.....	9-2
9.1.16	Updates to 00 Series TOs	9-2
9.1.17	Source, Maintenance, and Recoverability (SMR) Code Changes	9-2
9.2	Submitting Recommended Changes	9-2
9.3	Reviewing Recommended Changes	9-3
9.4	Evaluating Recommended Changes.....	9-3
9.4.1	General.....	9-3
9.4.2	Disposition Definitions.....	9-4
9.4.3	Disposition Remarks.....	9-4
9.5	Following-Up Recommended Changes	9-4
9.6	Recommendation Priorities	9-4
9.6.1	Emergency	9-5
9.6.2	Urgent	9-5
9.6.3	Routine.....	9-5
9.7	AFTO Form 22 Procedures.....	9-6
9.7.1	General.....	9-6
9.7.2	Providing Status Information	9-6
9.8	Recommended Changes and the Airmen Powered by Innovation (API) Program.....	9-6
10	NUCLEAR WEAPON CENTER (NWC), NUCLEAR RELATED EXPLOSIVE ORDNANCE DISPOSAL (EOD) AND NONNUCLEAR EOD TECHNICAL ORDER MANAGEMENT	10-1
10.1	Introduction.....	10-1
10.1.1	Nuclear Weapon and Nuclear Related EOD TOs.....	10-1
10.1.2	Intercontinental Ballistic Missile (ICBM) TOs	10-1
10.1.3	Nonnuclear EOD TOs	10-1
10.2	Contact Points.....	10-1
10.2.1	Nuclear Weapons Center and Nuclear Related EOD TOs	10-1
10.2.2	Nonnuclear EOD TOs and Data.....	10-1
10.3	Procedural Guidance.....	10-1
10.4	Technical Order Indexes	10-2
10.4.1	Nuclear Weapons ICBM and Nuclear Related EOD TO Indexes.....	10-2
10.4.2	Nonnuclear EOD TO Index	10-2
10.5	Nuclear Weapon ICBM and Nuclear Related EOD Technical Order Distribution Requirements.....	10-2
10.5.1	Establishing Nuclear Weapons Center and Nuclear Related EOD Technical Order Accounts (AFTO Form 43)	10-2
10.5.2	Ordering TOs (AFTO Form 186).....	10-2
10.5.3	Nuclear Weapons Center and EOD TO Approving Agencies.....	10-3
10.5.4	Nuclear Weapons TCTOs	10-4
10.5.5	Annual Validation of Nuclear Weapons Center and Nuclear EOD TO Requirements.....	10-4
10.5.6	Nuclear TODO Training	10-4
10.6	Nuclear Weapons Technical Order Procedures in Support of Foreign Governments	10-4
10.6.1	USAF Agency Actions for Nuclear Weapons TOs	10-5
10.6.2	Establishing a Nuclear Weapons-FMS-TODO (applies to Non-U.S. NATO organizations only).....	10-5
10.6.3	US Organizations Monitoring Loading of Special Weapons on Non-US Aircraft.....	10-5
10.6.4	Validating FMS Requirements and Requisitions for Nuclear Weapons TOs	10-5
10.6.5	FMS Release Approval	10-6
10.6.6	FMS Distribution.....	10-6
10.7	Nonnuclear Explosive Ordnance Disposal (EOD) Category 60 Technical Orders.....	10-9
10.7.1	Establishing Nonnuclear EOD Technical Order Accounts	10-9
10.7.2	Outside Agency Requests.....	10-9

11	TO SYSTEM TRAINING.....	11-1
11.1	General.....	11-1
11.2	Training Requirements.....	11-1
11.2.1	All TODO Personnel.....	11-1
11.2.2	TODA/Library Custodians.....	11-1
11.2.3	TO Users.....	11-1
11.3	Technical Order System Education and Training Resources.....	11-1
A	GLOSSARY OF REFERENCES AND SUPPORTING INFORMATION.....	A-1
A.1	Referenced and Related Publications.....	A-1
A.2	Related Forms.....	A-2
A.3	List of Acronyms.....	A-2
A.4	Glossary.....	A-6
B	ON-THE-JOB TRAINING SYLLABUS TECHNICAL ORDER DISTRIBUTION OFFICE (TODO).....	B-1
B.1	Reading.....	B-1
B.2	Training Resources.....	B-1
B.3	Training Requirements.....	B-1
B.4	Trainee Familiarization.....	B-1
C	ON-THE-JOB TRAINING SYLLABUS TECHNICAL ORDER DISTRIBUTION ACCOUNT (TODA) AND TECHNICAL ORDER LIBRARY CUSTODIAN.....	C-1
C.1	Reading.....	C-1
C.2	Training Resources.....	C-1
C.3	Training Requirements.....	C-1
C.4	Trainee Familiarization.....	C-1
D	ON-THE-JOB TRAINING SYLLABUS TECHNICAL ORDER USER.....	D-1
D.1	Reading.....	D-1
D.2	Training Resources.....	D-1
D.3	Training Requirements.....	D-1
D.4	Trainee Familiarization.....	D-1
E	DISTRIBUTION STATEMENTS AND CORRESPONDING REASONS FOR USE.....	E-1
E.1	Distribution Statements.....	E-1
E.1.1	DISTRIBUTION A.....	E-1
E.1.2	DISTRIBUTION B.....	E-1
E.1.3	DISTRIBUTION C.....	E-1
E.1.4	DISTRIBUTION D.....	E-1
E.1.5	DISTRIBUTION E.....	E-1
E.1.6	DISTRIBUTION F.....	E-1
E.1.7	DISTRIBUTION X.....	E-1
E.1.8	EXPORT CONTROL WARNING.....	E-1
E.2	Reason Statements.....	E-2

LIST OF ILLUSTRATIONS

Number	Title	Page
2-1	Types of TO Publications.....	2-14
2-2	Operations and Maintenance Technical Orders.....	2-15
2-3	Methods and Procedures Technical Orders.....	2-16

2-4	Abbreviated Technical Orders - Checklists	2-17
2-5	Abbreviated Technical Orders - Inspection Workcards	2-18
2-6	Time Compliance Technical Orders	2-19
2-7	Joint-Use Publications	2-20
2-8	Preliminary Technical Order and Formal Replacement	2-21
2-9	Example of an FMP Status Page	2-22
2-10	TO Page Supplements (TOPS).....	2-23
2-11	Identifying Technical Publication Sheet (ITPS) Cover Page for COTS Manuals	2-24
2-11.1	Commercial Manual Supplement (CMS) Change Package for COTS Manuals	2-25
2-12	Example of Merged TO Supplement View on Title Page of TO.....	2-28
2-13	Example of a T-2 Page.....	2-29
2-14	Example of an Abbreviated Title Page.....	2-30
2-15	Example of a List of Effective Pages.....	2-31
2-16	Format for Publications of Interim Safety/Operational Supplements (Except FMP Publication).....	2-32
2-17	Format for FMP Publication Interim Safety/Operational Supplements.....	2-33
2-18	Additional Format Options for Interim Safety/Operational Supplements	2-34
4-1	Establish TO Distribution Offices (TODOs) Process.....	4-10
5-1	TO Supplement Posting Guide.....	5-14
10-1	AFTO Form 186, Nuclear Weapons Technical Order Publications Request.....	10-7
E-1	Export Control Warning Label.....	E-1

LIST OF TABLES

Number	Title	Page
2-1	Local TO Title/Number Example.....	2-13
4-1	TODO/TODA/Library Custodian Checklist.....	4-7
8-1	Instruction for Completing DA Form 4790	8-1
9-1	AFTO Form 22 Detailed Completion Instructions	9-6
10-1	Nuclear Weapons Center and EOD (Nuclear and NonNuclear Related) TO Approving Agencies.....	10-3
10-2	Instructions for Completing of AFTO Form 43 for Establishment of NW-FMS-TODO.....	10-5
10-3	Instructions for Completing AFTO Form 186, Nuclear Weapons Technical Order Publications Request.....	10-8

FOREWORD

1. PURPOSE.

This technical manual provides clear and concise instructions for the safe and effective operation and maintenance of centrally-acquired and managed Air Force military systems and end items. The procedures in this TO are designed to implement the Air Force TO Vision: "...to provide user-friendly, technically accurate, secure and up-to-date digital technical data at the point of use that is acquired, sustained, distributed and available in digital format from a single point of access for all technical data users.

2. USE OF THIS MANUAL.

The table of contents indicates chapter, paragraph, title, and page numbers to facilitate location of information. Illustrations, tables, and diagrams, when applicable, are located throughout the publication to supplement the text material. A list of illustrations and a list of tables indicate the number, title, and location. Abbreviations, phrases, and words which are on a decal, a placard or an engraving are set forth in the text exactly as they appear on the decal, the placard or the engraving.

3. DEFINITIONS.

The word **SHALL** is used to express a provision that is binding. The words **SHOULD** and **MAY** are used when it is necessary to express nonmandatory provisions. **WILL** may be used to express a mandatory declaration of purpose or when it is necessary to express a future event.

4. ABBREVIATIONS AND ACRONYMS.

All abbreviations and acronyms used in this manual are in accordance with ASME Y14.38M, Abbreviations and Acronyms for Use on Drawings and Related Documents.

NOTE

Acronyms used only once in the TO are not included in this list.

Use acronym list from Appendix A, paragraph A.3.

5. LIST OF RELATED PUBLICATIONS.

These publications contain information in support of this technical manual. Use List of Related Publications from Appendix A, paragraph A.1.

CHAPTER 1

INTRODUCTION, SCOPE AND EXCLUSIONS

1.1 INTRODUCTION.

The Air Force Technical Order (TO) system provides clear and concise instructions for the safe and effective operation and maintenance of centrally-acquired and managed Air Force military systems and end items. The procedures in this TO are designed to implement the Air Force TO Vision: "... to provide user-friendly, technically accurate, secure and up-to-date digital technical data at the point of use that is acquired, sustained, distributed and available in digital format from a single point of access for all technical data users".

1.1.1 The Air Force TO System is established by Air Force Policy Directive (AFPD) 63-1/20-1, *Integrated Life Cycle Management*, and Air Force Instruction (AFI) 63-101/20-101, *Integrated Life Cycle Management*. This TO provides guidance and general management procedures for the Air Force TO System. This TO identifies and explains the various types of TOs (Figure 2-1), management tools, and procedures for TO accounts, ordering TOs, recommending TO updates, etc. References and related publications, related forms, acronyms and terms used in this TO are listed in the Glossary, Appendix A.

1.1.2 When consulting this TO for procedural information (for example, ordering TOs), the reader should consider reading the appropriate chapter from the major chapter heading down to the detailed subparagraph of interest. This will provide the user with context and common information associated with the detailed procedure. However, the table of contents includes direct links to subparagraphs for experienced users. The TO is also "text searchable" should the user require information on a specific topic.

1.1.3 TOs for individual systems and end items are managed by TO Managers assigned by the responsible Program Manager (PM) or Supply Chain Manager (SCM). TO managers are responsible for managing the configuration of TOs and providing users with accurate, reliable and timely data. Individual TO currency and accuracy is the responsibility of assigned Technical Content Managers (TCMs). Flight Manual Managers (FMMs) are the equivalent of TCMs for Flight Manual Publications (FMP) (reference AFI 11-215, *USAF Flight Manuals Program (FMP)*).

1.1.4 Air Force personnel should first refer TO system policy and procedure questions to their Command Technical Order Distribution Office (TODO) and then the focal point identified in their MAJCOM supplement to this TO. Otherwise, refer TO policy and procedure questions to the AF TO Policy and Procedures (AF TOPP) team, HQ AFMC/A4FI, 4375 Chidlaw Rd, Ste 6, WPAFB OH 45433-5006, e-mail: afmc.a4.af.topp@us.af.mil. Refer questions on specific TO system tools to the Office of Primary Responsibility (OPR) listed in Chapter 3. Request waivers to TO System policy and procedures using the format and procedures on the Policy Integration Air Force Network (AFNET), accessible via the portal at <https://cs3.eis.af.mil/sites/OO-EN-TO-PI/default.aspx>. Changes to this TO shall be submitted in accordance with Chapter 9.

1.2 SCOPE.

The Air Force TO System includes the TOs, infrastructure, training and resources to manage and use TOs. TOs include all manuals developed or acquired for organic operation, maintenance, inspection, modification, or management of centrally acquired and managed Air Force systems and end items. This includes manuals for paper and electronic data delivery developed IAW Technical Manual Specifications and Standards (TMSS), non-embedded personal computer software which automates the function directed by a TO, contractor-developed manuals adopted for Air Force use, and approved Commercial Off-The-Shelf (COTS) manuals. Each TO is assigned a unique TO number in the Air Force Standard TO Management System for configuration control according to the types of equipment covered, to provide sequences for filing and indexing, and to provide a means for users to identify and establish requirements for distribution of TOs.

1.3 TO PRECEDENCE.

1.3.1 The hierarchy for Air Force TO policy is as follows: 1) Public Law; 2) Defense Federal Acquisition Regulations (DFAR) & Supplements; 3) DoD publications; 4) Air Force publications; 5) TOs and MAJCOM publications. Air Force Instructions (AFI) establish policies and responsibilities for the implementation of Air Force Policy Directives (AFPD) while Air Force Technical Orders provide instructions for the operation and maintenance of Air Force military systems and end items. As such, AFIs should not contain detailed, technical procedures. In the event a detailed, technical procedure is published in an AFI and the procedure conflicts with a weapon system or equipment TO, comply with the procedure in the

TO 00-5-1

TO and submit an AF Form 847 to have the procedure removed from the AFI. In the event of a conflict between a specific military system or end item TO and a general TO, the specific TO shall take precedence. In cases of conflict between a TO and other publications, contact the PM/SCM to resolve the conflict.

1.3.2 Conflicting procedures which compromise personnel safety or mission accomplishment shall be resolved by local commanders and reported using the recommended change process IAW Chapter 9 for formal resolution.

1.3.2.1 In case of a conflict between procedures in general TOs and Air Force Occupational Safety and Health (AFOSH) Standards, follow the more restrictive requirement.

1.3.2.2 In case of a conflict between procedures in Mission/Design/Series (MDS)-specific TOs and AFOSH Standards, the MDS-specific TO shall take precedence. In case of conflict between procedures in general TOs, follow the more restrictive requirement.

1.3.2.3 Local commanders are authorized to allow operations to continue if minor technical errors or step omissions are encountered as long as safety, security, or effectiveness is not compromised. Recommended change process is still required IAW Chapter 9.

1.3.3 The basic TO, as the source document for checklist and workcards information, may be used in place of workcards and checklists in the performance of maintenance. In the case of a conflict between the basic TO and the abbreviated TO, the basic TO shall take precedence.

Exceptions:

1.3.3.1 Inspection workcards (TOs including -6WC as part of the number) take precedence over inspection manuals (TO numbers ending in -6).

1.3.3.2 Generic periodic and servicing inspection work cards for aerospace ground equipment (AGE) that identify affected equipment items by type, model, part number or stock number, and the applicable end-item TO/Series contain all known and relevant inspection requirements. Should any other TO or maintenance directive be in conflict with the requirements stated in these work cards, the work cards shall take precedence.

1.3.4 When specific TOs do not contain procedures or processes such as cleaning, plating, etc., general TOs containing such information shall be used.

1.3.5 The Reliability and Maintainability Information System (REMIS) provides "push-down" tables containing Work Unit Codes (WUC) manual data for most systems and end items. These tables, when available, take precedence over printed WUC (-06 series) manuals. See TO 00-20-2, *Maintenance Data Documentation*, for further information.

1.3.6 When Air Force equipment is operated as a part of the defense communications system, Defense Information Systems Agency (DISA) Directives shall take precedence over TOs for those areas affecting system interface.

1.3.7 Pre-production or non-configured items accepted into the Air Force inventory shall be operated and maintained according to the latest technical data developed (PTO, COTS, contractor data, etc.) which is compatible with the specific configuration of the equipment with concurrence of the PM/SCM and Lead Command. This technical data may have been superseded by TOs on later, production configured versions of the items, and therefore, might not be listed in the TO Catalog.

1.3.8 When technical manuals developed for other services or departments are used by the Air Force, maintenance levels, record keeping requirements, or additional authorizations for tools and equipment shall be accomplished IAW Air Force policy as precedent over other agency policies. See AFI 20-118, *Instructions for the Interservicing of Technical Manuals and Related Technology Program*.

1.4 EXCLUSIONS.

The TO System does NOT apply to publications for:

1.4.1 Contractor-operated experimental equipment designed for research.

1.4.2 Operation and maintenance of real property or real-property-installed equipment as defined in AFI 32-9005, *Real Property Accounting and Reporting*.

1.4.3 Subjects more suitable for coverage in standard publications (AFI 33-360, *Publications and Forms Management*) and subjects covered in other specialized publication systems.

1.4.4 Embedded computer programs managed according to AFI 33 series (Communications and Information) instructions, and the USAF Computer Program Identification Numbering System covered in TO 00-5-16, *Software Managers Manual -- USAF Computer Program Identification Numbering (CPIN) System*.

1.4.4.1 If TODO personnel manage CPIN, the appropriate block is marked in Block 1 of the account AFTO Form 43, *USAF Technical Order Distribution Office (TODO) Assignment or Change Request*.

1.4.4.2 See paragraph 2.1.9 for computer-related manuals managed in the TO System.

1.4.5 Systems or equipment to be maintained and operated by the original manufacturer or a contractor over its life cycle. Policy on data to support these systems and end items is in AFI 63-101/20-101.

1.4.6 Communications-Computer Systems Security and nonstandard cryptologic systems and equipment operated and maintained by National Air and Space Intelligence Center (NASIC).

1.4.7 Numerical Control (NC) programs.

1.4.8 Command-supported and/or fabricated equipment not centrally acquired.

1.4.9 Joint Munitions Effectiveness Manuals (See Technical Handbook 61JTTCG/ME-1-2-index).

NOTE

Joint Munitions Effectiveness Manuals (JMEM) may be obtained by contacting the Joint Product Office at Tinker AFB, AFLCMC/LGLZP. E-mail: jmem@tinker.af.mil

1.4.10 Security Assistance Programs (SAP) when the military system or end items being provided are unique. (See TO 00-5-19, *Security Assistance Technical Order Program*.)

1.4.11 Procedures addressed in TO 00-25-107, *Maintenance Assistance*, and TO 00-25-108, *Communication-Electronics (C-E) Depot Support* that fit one or more of the following categories: (a) are unique to specific serial numbered equipment item; (b) are expected to expire in 120 days or less; (c) are for one-time use; or (d) are not applicable to all users or units of the system or end item.

1.5 AIR FORCE TECHNICAL ORDER USE.

Prior to starting any task, all applicable TOs must be reviewed for familiarization with the latest procedures. During use, all TO users must review TOs for accuracy, currency and security classification. Review Verification Status Pages (VSP), when present, to check the verification status before attempting to use any procedure.

CHAPTER 2

TECHNICAL ORDER (TO) TYPES, SUPPORT DATA, UPDATES AND FRONT MATTER

SECTION I TYPES OF TECHNICAL ORDERS

NOTE

For information on TO categories, see TO 00-5-18, Chapter 1.

2.1 OPERATIONS & MAINTENANCE (O&M) TECHNICAL ORDERS.

O&M TOs cover installation, operation, troubleshooting, repairing, removing, calibration, servicing or handling of Air Force military systems and end items. O&M TOs must be available and used at the job site. Examples are listed below.

2.1.1 Flight Manual Program (FMP) Publications. These TO Category 1 publications contain information on an aircraft, its equipment, operation and characteristics. FMP publications include Basic Flight Manuals (-1 series), Air Refueling Procedures (1-1C-1 series), Basic Weight Checklist and Loading Data (-5 series), Functional Check Flight (-6CF series), Cargo Aircraft Loading Manuals (-9 series), Cargo Aircraft Nuclear Weapon Loading (-16 series), Nuclear Weapon Delivery (-25 through -31 series), Nonnuclear Weapons Delivery (-34 series) and Mission Operation (-43 series), and any other applicable MDS specific FMPs.

2.1.2 On-Equipment Organizational Maintenance Manual Sets. These TO sets include Job Guides (JG), General Vehicle (GV) TOs, Wiring Diagram manuals, etc. They also provide detailed procedures in step-by-step form for on-equipment operational checkout, test, repair, adjustment, and removal and replacement of accessories. Job Guides are normally prepared in reduced size.

2.1.3 Nuclear Weapons Manuals. These manuals provide information on handling, transporting, maintenance and nuclear weapons specific support equipment. See Chapter 10 of this manual.

2.1.4 Nonnuclear Weapons Delivery Manuals. These manuals consist of munitions loading TOs, weapons delivery TOs, nonnuclear Explosive Ordnance Disposal (EOD) manuals, and manuals for munitions handling, transportation, maintenance and inspection.

2.1.5 Aircraft Emergency Rescue Information. TO 00-105E-9 provides required system information and establishes emergency rescue procedures for use during various types of ground emergencies on military and commercial aircraft.

2.1.6 Communications-Electronics Manuals. These Standard Installation Practices TOs (SIPTOs) manuals include facility, system, subsystem, installation engineering and installation manuals, general engineering and planning manuals, and standard installation practices TOs.

2.1.7 Work Package TOs. These intermediate/organizational/depot maintenance manual sets contain individual Work Packages (WP) that provide detailed procedures in step-by-step form, to accomplish specific maintenance tasks. Because all applicable WPs are contained in each TO numbered set, individual WPs can not be requisitioned.

2.1.8 Calibration TOs. These 33K-series manuals provide instructions for off-equipment calibration of Test, Measurement and Diagnostic Equipment (TMDE).

2.1.8.1 Calibration procedures for non-stock listed measuring equipment are authorized and listed in TO 33K-1-100-1, *Calibration Procedure for Maintenance Data Collection Codes and Calibration Measurement Summaries.*

2.1.8.2 AFMETCAL, 813 Irving-Wick Dr W, Ste 4M, Heath OH 43056- 1199, is responsible for publishing and distributing calibration TOs, and is a member of the Joint Technical Coordinating Group for Calibration and Measurement Technology IAW AFI 21-113, *Air Force Metrology and Calibration (AFMETCAL) Management.*

TO 00-5-1

2.1.9 Computer-Related Manuals. Operator manuals for embedded computer software that provide instructions on loading and system operation may be managed in the TO System.

2.2 GENERAL, METHODS AND PROCEDURES TECHNICAL ORDERS.

2.2.1 General TOs. If the number 1 is used in lieu of a specific equipment identifier, the TO is a general technical order (category general, system general, or equipment-series general TO). Category general TOs apply to more than one type of aircraft, missile or engine or to more than one equipment system in the category. System general TOs apply to a system installed on more than one type of aircraft, missile or engine. Equipment-series general TOs apply to more than one subseries of equipment within the equipment series.

2.2.2 Methods and Procedures TOs (MPTOs). See Figure 2-3. MPTOs (Category 00) are general in content and are not issued against specific military systems or end items. They include:

2.2.2.1 TOs that specify methods and procedures relating to the TO system, maintenance management, administration, inspection of Air Force equipment, control and use of repairable assets, configuration management, etc. The policy governing employment of the methods and procedures contained in these TOs is contained in the corresponding Air Force or MAJCOM level instruction. For example, TO 00-5-1 implements AFI 63-101/20-101.

2.2.2.2 TOs that involve instructions, methods and procedures relating to ground handling of air and space vehicles, general maintenance practices, management of precision measurement equipment, and the safe use of Air Force equipment. An example is TO 00-25-234, *General Shop Practice Requirements for Repair, Maintenance, and Test of Electrical Equipment.*

2.2.2.3 MPTOs are not required at the job site for DoD personnel. MPTOs are required for contractor personnel at the job site when listed in the Statement of Work (SOW) and directive upon the contractor.

2.3 INDEX TECHNICAL ORDERS.

Indexes provide a means of identifying needed TOs, group TOs pertaining to specific items of equipment, and show the status of all TOs. Examples are:

2.3.1 TO Catalog. See paragraph 3.2.1 and paragraph 3.3 .

2.3.2 Special TO Indexes. These indexes cover special classes of TOs, such as Air Force Nuclear Weapons Center (AFNWC) support (0-1-11N-1-CD-1) and those TOs used only by SAP countries .

2.3.3 Enhanced Technical Information Management System (ETIMS) Table of Contents (TOC) TO. Enhanced navigation between the ETIMS electronic TOs (eTOs) listed in the TOC TO through the use of Hyperlinks (00-5-1 and 00-5-3). The eTOs listed in the ETIMS TOC TOs are normally associated with a specific weapon system. The ETIMS TOC TO have Category 0 numbers (e.g., the ETIMS TOC TO for the C-17A would be 0-0-1C-17A-TOC-1-WA-1).

2.3.4 Lists of Applicable Publications (LOAP). These TOs provide a listing of all TOs applicable to a specific military system and related end items. These TOs facilitate selection of, or familiarization with, publications for the system covered.

2.4 ABBREVIATED TECHNICAL ORDERS.

See Figure 2-4 and Figure 2-5. These TOs are excerpts from one or more basic TOs that organize and simplify instructions. The following are types of abbreviated TOs.

2.4.1 Inspection Workcards. Workcards are developed in sets by type of inspection, and (normally) work area or zone being inspected. Workcards provide the required guidance, including applicable safety warnings, cautions and notes and specific accept/reject criteria for performing an inspection.

2.4.2 Inspection Sequence Charts. These are limited-use tools provided for scheduled inspections and depict a basic planned work schedule or sequence in which the inspection workcards can be used.

2.4.3 Checklists. Checklists provide abbreviated step-by-step procedures for operation and maintenance of systems and equipment in the sequence deemed most practical, or to determine operational readiness of equipment and minimum serviceable condition. Not every task or common maintenance practice must be or will be covered by a checklist. A checklist may be published when one or more of the following criteria exist:

2.4.3.1 When sequential steps must be followed to preclude potential damage or degradation to equipment that would reduce operational readiness or cause catastrophic failure.

2.4.3.2 To preclude potential injury to personnel and/or damage to equipment unless prescribed sequence time-phased procedures are followed.

2.4.3.3 When interaction or communication between two or more differing specialty skills is involved in accomplishing a function.

2.5 BRIEF MANUALS.

TOs are considered to be brief manuals when they are twenty pages or less in length. Brief manuals only require an abbreviated title page with no additional front matter. These manuals can have chapters or sections that begin on left- or right-hand pages with no blank pages; contain more than one chapter or section on a page; have pages, paragraphs, illustrations and tables numbered consecutively throughout the manual with single Arabic numerals; and contain the words “THE END” following text on the last page. Brief manuals are always revised, never changed.

2.6 TIME COMPLIANCE TECHNICAL ORDERS (TCTO).

See Figure 2-6. TCTOs are the authorized method of directing and providing instructions for modifying military systems and end items or performing one-time inspections. TCTOs are categorized as Immediate Action, Urgent Action, Routine Action, and Record . The category determines the compliance period. Detailed procedures on TCTO processes are provided in TO 00-5-15, Air Force Time Compliance Technical Order Process.

2.7 SUPPLEMENTAL MANUAL TECHNICAL ORDERS.

These TOs contain instructions for use in conjunction with data contained in their parent TOs and are not stand-alone publications. The title page and a TO Catalog note will state: “This manual is incomplete without TO XXXXXX-XX.” Supplemental manuals are not temporary updates like TO supplements, and are assigned a separate TO “dash” number. Although supplemental manuals are ordered like any other TO, the basic TO must also be ordered to provide complete procedures/data. Supplemental manuals may be used to publish classified data while allowing the parent manual to remain unclassified, to publish data provided by a source other than the Program Manager (PM) or SCM responsible for the TO, and/or to publish data in a form other than the parent TO. EXAMPLES: 1) a table containing classified weapon data used with a weapons delivery TO in building mission profiles; 2) aircraft deicing criteria provided by the Federal Aviation Administration (FAA); and 3) rapidly-changing data published on the Internet to improve the timeliness and accuracy of the technical data.

2.8 JOINT-USE PUBLICATIONS.

See Figure 2-7. Technical manuals (TM) developed for other services or government departments are authorized for use by Air Force personnel if the TMs meet Air Force operational and maintenance needs. (See AFI 20-118 and AFI 63-101/20-101.) Joint-use publications may be integrated into the TO system, assigned TO numbers, indexed, distributed, stored, reprinted, maintained and rescinded in the same manner as any other Air Force TO.

2.9 COMMERCIAL OFF-THE-SHELF (COTS) MANUALS.

COTS manuals support equipment designed and manufactured for commercial use are furnished or sold by equipment manufacturers to customers. COTS manuals commonly provide operating instructions, technical information for installing, servicing and repairing the equipment item and a parts list to assist in ordering replacement parts. Commercial flight manuals developed according to Air Transport Association (ATA) Specification 100 may also be used. COTS manuals and supplemental data approved for Air Force use are assigned a TO number, managed, referenced and used like any other TO. With the exception of flight manuals, preliminary copies of COTS manuals delivered with the supported equipment are authorized for use pending Air Force review and assignment of TO numbers. The manufacturer’s distribution formats may include paper, CD/DVD or online file.

SECTION II SUPPORT DATA

2.10 SERVICE BULLETINS, OPERATIONS MANUAL BULLETINS, FAA AIRWORTHINESS DIRECTIVES, TEMPORARY REVISIONS, AND LIKE DATA.

These publications provide information and instructions on commercial systems and end items, similar to those provided in inspection TOs, TO supplements, and TCTOs. The PM or SCM acquires these publications IAW AFI 63-101/20-101 and TO 00-5-3. These publications will be accepted, numbered and used like other COTS manuals or supplemental data.

2.10.1 The TCM, depot engineering or technical support activities and/or FMM, determine if these publications apply to TO-numbered flight and/or maintenance manuals, and if the publications will be referenced in the TO by the assigned commercial number or have the information extracted for inclusion in TO updates. Because Air Force and commercial roles and responsibilities for flight crews and ground crews are different, changes affecting only commercial maintenance personnel may also apply to military flight crews, and vice versa.

2.10.2 Commercial publications directing modifications to systems or end items (other than temporary modifications) and initial or one-time inspections to be performed by Air Force organic resources are numbered and managed as TCTOs IAW TO 00-5-15. TCTO numbers are issued for technical instructions which update the configuration of Contractor Logistics Support (CLS) managed systems and end items when configuration control is the responsibility of the Air Force. For publications directing work to be performed by contractors, the responsible activity will determine whether a TCTO number will be assigned. This may result in TCTO numbers being assigned and managed within the TO system for O&M manuals managed outside the system.

2.11 CONTRACTOR DATA.

Contractor data is developed by the contractor for use in supporting TO development, production, Research and Development (R&D) programs, Interim Contractor Support, CLS, etc. It can contain all forms of technical data, including manuals, documents, pamphlets, instructions, engineering drawings, etc. Contractor data includes Factory Test Equipment and Special Test Equipment data. Air Force personnel may use contractor data when CLS/Contractor Support (CS) contracts specify Air Force assistance to the contractor or when operating or maintaining equipment at sites or locations not covered by the contract, for example, overseas and/or remote locations. No other authorization is required except for munitions manuals. If Air Force personnel are conducting munitions operations (munitions loading, handling, etc.), authorization is warranted by the respective Lead Command.

2.12 OTHER AUTHORIZED SUPPORT DATA.

Other types of data, described below, are used to support operation and maintenance of Air Force equipment and for the development of TOs. This support data is not managed in the TO system.

NOTE

Technical data release procedures described in paragraph 7.1, TO Dissemination Control, applies to support data as well.

2.12.1 Source Data. Source data is used in the TO system for the development or update of TOs. There are several different types and formats of source data, including engineering documentation, Supportability Analysis Records and contractor data; the type and format depends on the specific needs of the TO program. Source data may be developed organically or acquired from contractors IAW TO 00-5-3.

2.12.2 Engineering Drawings. When referenced in the TO or authorized by the PM/SCM IAW TO 00-25-107 or TO 00-25-108, Air Force technicians may requisition and use engineering drawings for reference. Technicians may either access digital aircraft and equipment drawings from the Joint Engineering Data Management Information and Control System (JEDMICS) or requisition paper drawings by letter or telephone from the PM/SCM having engineering responsibility for the affected system or end item. To access digital drawings from JEDMICS, technicians should first establish a remote JEDMICS access account based on the guidance at <https://jedmics.tinker.af.mil/>.

2.12.3 Locally Prepared Workcards, Checklists, Job Guides and Page Supplements. Locally prepared workcards, checklists, job guides and supplements formalize and control procedures unique to a base or area, and which do not apply or

are not suitable for all TO users. These locally prepared, technical order related, publications are generally formatted and used like TOs and will be indexed in ETIMS as private TOs by the TODO. Manage locally prepared publications according to AF instruction or MAJCOMs guidance. Local publications are considered authorized for use when the AF Form 673, *Request to Issue Publication*, is signed by the applicable Group Commanders, authority delegated by the Group Commander, or authority identified by MAJCOM guidance.

2.12.3.1 The preparing activity assigns individual identification numbers to local workcards, checklists, and job guides for control purposes. TO numbers alone will not be used to identify local data, but can be used as a part of the identification number. Identification numbers shall consist of LWC (workcard), LCL (checklist), or LJG (job guide) followed by the originating organization designation and the TO number or a designator selected by the originator.

2.12.3.2 Locally prepared publications must also include a title page with the number, title and date of the TO affected, the issue date of the local document, and List of Effective Pages (LEP), locally generated pages and posting instructions.

2.12.3.3 For local publications, all parent TO procedures will be followed. No requirements for additional tools or test equipment will be introduced. Local publications will have distribution statements assigned IAW DoDI 5230.24, *Distribution Statements on Technical Documents*, consistent with the classification level and restrictions of the parent document see Appendix E.

2.12.3.4 Local page supplements should be printed on colored paper (other than green) to distinguish them from other TO increments. Workcard page supplements that establish additional inspection requirements can use any format that provides all applicable data captions. Procedures for local page supplements will normally be similar to those for TO Page Supplements (TOPS).

NOTE

For MAJCOM, Base and Unit Supplements, units should follow procedures found in paragraph 2.18 to supplement the TO.

2.12.3.5 Copies of all locally developed workcards, checklists, and job guides may be forwarded by cover letter to the MAJCOM or gaining command to be reviewed for command-wide application (MAJCOM option). Those adopted command-wide may be forwarded to the PM or SCM for consideration for Air Force-wide application.

EXCEPTIONS: Local workcards for “training use only” air and space vehicles and support equipment will be kept at the local level. Local workcards for ground C-E equipment (except CRYPTOLOGIC equipment) that is not listed in the Reliability and Maintainability Information System Standard Reporting Designators push down table will be retained at the local level.

2.12.3.6 See TO 00-20-14, *Air Force Metrology and Calibration Program*, for procedures concerning locally developed calibration data.

2.12.4 Other Data. It may be necessary for the TO Manager to authorize temporary use of other types of data, such as preliminary (unpublished) TO changes, engineering data or contractor source data. (For example, contractor installation source data used to support maintenance on a prototype TCTO-modified aircraft until the TCTO and related TO changes can be published.) Using organizations may use preliminary data for hands-on training, operations, or maintenance when verified and authorized by the PM or equivalent along with concurrence from the Lead Command. Authorization for the use of preliminary data shall not exceed 180 days unless readdressed. The authorization memorandum must accompany the data at all times. Documentation that provides data beyond the scope of authorized TOs, or provides authorization to deviate from published TO parameters is authorized IAW TOs 00-25-107 or 00-25-108, and for depot use according to command publications. The documentation is provided to avoid and resolve work stoppages or when there is a critical need for an item.

2.13 PRELIMINARY TECHNICAL ORDERS (PTO).

See Figure 2-8.

2.13.1 PTOs are prepared in limited quantities during TO acquisition to support In-Process Reviews (IPRs), contractor certification, and government verification of data. The TO Catalog identifies and lists PTOs so potential users can subscribe to the TOs. PTOs cannot be requisitioned through the TO system. If PTOs are required prior to formalization, contact the TO Manager for distribution. PTOs are formalized IAW TO 00-5-3. Using organizations may use PTOs for hands-on training, operations, or maintenance when verified and authorized by the PM or equivalent along with concurrence from the Lead

TO 00-5-1

Command. Authorization for the use of preliminary data shall not exceed 180 days unless readdressed. The authorization memorandum must accompany the data at all times.

2.13.2 Using Command Verification. When PTOs or partly verified formal TOs must be distributed, operational units may be required to verify some procedures on site. For operational unit verification, the following requirements and procedures will apply:

NOTE

PTOs will be watermarked. The watermark should state the PTO is not for field use

2.13.2.1 The unit Product Improvement (PI) office or other responsible function will monitor and control the verification effort. For FMP publications, the unit Standardization Evaluation (Stan Eval) will perform this function. The verification monitor will contact the TO Manager or FMM (identified on the Verification Status Page) and request permission to perform unit-level verification of the procedure involved. If necessary, the TO Manager or FMM will arrange for ALC or verification team on-site support. For calibration TO (Category 33K) verification, see TO 00-20-14 .

NOTE

For major tasks, such as wing or stabilizer removal and replacement and any task involving nuclear weapons or critical components, on-site verification team (TO 00-5-3) support must be provided.

2.13.2.2 The operational unit shall determine the availability of personnel, support equipment, special tools, spare parts and consumables required to accomplish the task.

2.13.2.3 When the on-site verification team (if required) and all support requirements are available, the procedure will be performed under PI supervision. PI will record any discrepancies found during the effort.

2.13.2.4 If discrepancies are found, the procedures will be corrected on-site if possible. Major problems, especially those that could cause personnel injury or equipment damage, may require TO Manager or depot support. All discrepancies will be reported using the AFTO Form 22, *Technical Manual (TM) Change Recommendation and Reply*, AFTO Form 27, *Preliminary Technical Order (PTO) Publication Change Request (PCR)/TO Verification Record/Approval*, or AF Form 847, *Recommendation for Change of Publication* IAW Lead Organization or PMs reporting requirements.

2.13.2.5 Upon successful completion of verification, the TCM or TO Manager will be notified via one of the forms listed above, and the unit will annotate completion on the VSP.

SECTION III TECHNICAL ORDER UPDATES

2.14 DIFFERENCE DATA SHEETS.

Difference data sheets are used to provide information on additional models of equipment which constitute minor changes from the basic design. Separate Difference Data Sheets may be prepared for each additional model covered. Users of technical orders containing difference data sheets must review all applicable difference data sheets before commencing the work.

2.15 TECHNICAL ORDER REVISIONS.

A revision is a second or subsequent edition of a TO that supersedes (replaces) the preceding edition. A revision incorporates all previous changes, supplements and new data that would normally have required a separate update into the basic TO. When the only TO distribution format is as a digital TO (see paragraph 6.1.1 for digital defined in terms of technical data) formal updates are exclusively published, indexed and distributed as revisions. When the distribution format is both eTO and paper, formal updates to the digital TO file are indexed as revisions dated the same as the update, and with the updates merged (posted) to the basic file to mirror the paper version for distribution.

2.16 TECHNICAL ORDER CHANGES.

Changes are issued when only part of the existing TO is affected. TO changes are assigned the same TO number as the basic TO, with a publication stock number (PSN) identifying the change number. A change title page has the word "CHANGE", a

change number and a change date added at the bottom right corner of the title page. New pages in a TO change replace the corresponding numbered pages in the existing TO.

2.16.1 Added Pages. If a TO change contains new material that cannot be included on an existing page, new pages are inserted between or after the affected pages: added pages can only be inserted after an even page number. Added pages are assigned the preceding page number and a suffix, such as 2-2.1 or 2-2A, etc., depending on the style of the manual, and will be consistent throughout the manual. When pages are added at the end of a chapter or section, continue the page numbering in normal sequence. Blank pages are used as needed to avoid renumbering or issuing more than the minimum number of subsequent pages.

2.16.2 Change Page Marking. The applicable change numbers are reflected next to the page number on each of the changed pages. Whenever feasible, change markings (e.g., vertical black lines in page border, light grey shading, underlining, etc.) will indicate where new text changes occur in an update or revision. Corrections of minor inaccuracies of a non-technical nature such as spelling and punctuation will not be indicated with change marking unless the correction changes the meaning of instructive information and procedures. A miniature pointing hand will be used to indicate updates to illustrations or line drawings. Shading and screening will be used to highlight updated areas on diagrams and schematics. Changes that alter procedures or technical information dependent upon the configuration of equipment, such as TCTO-related before and after data, will be differentiated by use of "Effectivity Codes". The codes and associated meanings will be listed in the TO Foreword/Preface/Introduction. Digital TOs will use similar markings to indicate changed data.

2.16.3 Rapid Action Changes (RACs). Digital TO change files which implement emergency or urgent TO changes, within IOS/ISS timelines (paragraph 2.17.4). When the TO distribution format is only eTO, the emergency or urgent TO change information is appended, annotated and merged to form a complete eTO before distribution. When the TO distribution format is both paper and eTO, the TO change file is made available for download, printing and posting by paper TO subscribers while the complete eTO mirrors the paper TO with the changes posted. RACs are not to be used if update timelines can be met by a routine in-work change, or it is cost effective to produce an out-of-cycle change.

2.16.3.1 A RAC includes, as a minimum, the TO title page, LEP, at least one page changed by the Emergency or Urgent update, and a corresponding backing page for each changed page (to support paper users). The title page includes a Supersedure Notice identifying the affected TO basic date and superseded changes and supplements.

2.16.3.2 TODOs are notified of RAC publications via ETIMS notification. If the TO is available as -WA-1, TODOs will download using ETIMS and locally print RAC attached to -WA-1 version of TO. If the TO is not available in -WA-1 format, TODOs will follow instructions in ETIMS catalog notes on how to obtain TO content updates.

2.16.3.3 When the TO distribution format is both paper and digital delivered eTOs, the change will be posted and apparent in the digital format delivered.

2.17 TECHNICAL ORDER SUPPLEMENTS.

NOTE

Technical Order Page Supplement (TOPS) are not authorized for use in TOs indexed in ETIMS which are distributed through TODPS or ETIMS eTO viewed (see TO 00-5-3).

Supplements augment or change data in the basic TO without replacing the existing pages. Supplements will have the same title as the supplemented TO, but will be assigned a specific TO number, differing from the affected basic TO number by addition of suffixes (see TO 00-5-18). Supplements are integral parts of the basic publication and will be maintained in all libraries where the basic is required. Supplements list the affected page, paragraph, figure number, etc., and provide the added, changed or deleted information. Authorized types are formal Operational and Safety Supplements (OS, SS) and Interim Operational and Safety Supplements (IOS, ISS), TOPS, and formal and interim TCTO supplements. TCTO supplements are covered in TO 00-5-15. The use of supplements and TOPS is strictly controlled to prevent degradation of TO usability. TO changes and revisions will be published instead of formal OS and SS or TOPS; RACs will be issued instead of Interim Operational Supplements (IOS) and Interim Safety Supplement (ISS), to the maximum extent possible.

2.17.1 General. Some policies apply to all types of supplements. These are:

EXCEPTION: FMPs may be supplemented using page changes IAW AFI 11-215.

TO 00-5-1

2.17.1.1 Supplementing supplements is not authorized.

2.17.1.2 Do not issue supplements to isolate classified material so unclassified basic TOs can be published, but issue supplemental TOs instead.

2.17.1.3 Supplements can be cumulative or non-cumulative. A cumulative supplement supersedes all other active supplements and includes all previously published information not already incorporated into the basic TO. Non-cumulative supplements are independent of other unincorporated supplements.

2.17.1.4 Whenever the added, changed or deleted information is applicable to more than one TO, individual supplements will be issued for each TO involved.

2.17.1.5 When changed data in a supplement is not fully incorporated in the next TO update, the unincorporated data will be reissued as a new supplement. If a supplement will not be incorporated (paragraph 2.17.4.10), it must be reissued when a TO revision is issued.

2.17.1.6 Rescinded supplements will not be reinstated. A new supplement will be issued when necessary to include valid data from a rescinded supplement.

2.17.1.7 Issue safety supplements only to correct conditions involving possible fatality or serious injury to personnel, or extensive damage or destruction of equipment or property. Issue operational supplements to change information in TOs when work stoppages, production stoppages or mission essential operational deficiencies are involved.

2.17.1.8 If the data in a supplement affects both a TO and the associated checklists/workcards, separate supplements or formal changes shall be issued for each publication. FMP publications will follow the guidance published in AFI 11-215.

2.17.2 Formal Supplements.

2.17.2.1 Formal operational and formal safety supplements will only be issued to update:

- TMs managed by other services
- Commercial Manuals
- FMP publications (according to AFI 11-215)
- Other TOs with temporary updates (with the express permission of the Lead Command functional manager). (Examples: reduced power levels or additional safety precautions pending completion of a TCTO).

2.17.2.2 Supersede formal supplements directing permanent TO updates in the next routine TO change or revision, not to exceed one year after issue. Formal supplements containing temporary data (for example, flight restrictions pending completion of inspections or other TCTOs, before data for TCTOs with a compliance period less than two years) may remain active for up to 30 months. Formal OS and SS are posted in the same manner as interim supplements.

2.17.2.3 Routine formal supplements are only issued to TCTOs, commercial manuals and joint use publications such as Army manuals adopted for Air Force use. Routine supplements to TCTOs are covered in TO 00-5-15. Routine supplements for technical manuals are covered in MIL-STD-38784, *Standard Practice for Manuals, Technical: General Style and Format Requirements*. Routine supplements shall not be issued as Interim TOs or RACs. Routine supplements are lettered and posted in back of the TO, while commercial manual supplemental data are assigned supplement letters and are posted in the back of manuals. Identifying Technical Publication Sheets (ITPS) (paragraph 2.17.5) only have the TO number and are posted immediately on top of the commercial manual title page and safety summaries should be posted directly behind the ITPSs. When an ITPS is required after initial publication of a paper TO, the ITPS will be issued as an attachment to a routine formal supplement.

2.17.2.4 For joint-use TMs, each service is responsible for publishing service unique supplements when the need arises. The lead service TCM and the TCMs from using services must establish standard update procedures to ensure urgent and routine information is provided to TM users in the appropriate time frames. TCMs must review technical content changes prior to publication by the lead service, determine applicability and distribute only those applicable to the using service.

2.17.3 TO Page Supplements (TOPS). See Figure 2-10. TOPS are issued to supplement individual pages of a TO. TOPS shall not be used to update TOs except for systems with ongoing modification programs, and then only with the express written permission of the Lead Command for the system. TOPS shall not be used to update digital TOs for any reason. For other systems and end items, information formerly provided via TOPS must be issued in TO changes or RACs. Where both before and after modification data is required (as with TCTO related changes), effectivity codes (paragraph 2.16.2) are used to differentiate between paragraphs applicable to different versions/modifications of the affected equipment.

Supersede TOPS directing permanent TO updates in the next routine TO change or revision, not to exceed one year after issue. TOPS with temporary updates may remain in effect for up to 30 months.

2.17.3.1 When paper copies of TOs are being used, TOPS are printed on green paper to distinguish them from other supplements. TOPS have the same title as the basic TO. TOPS can be cumulative or noncumulative. A cumulative TOPS contains only new or changed TOPS data pages, even though it lists all unreplaced pages from prior TOPS. Unchanged TOPS data pages are not reissued. Users do not remove unchanged TOPS pages from affected TOs.

2.17.3.2 TOPS use an abbreviated title rather than a full title page, with the LEP placed directly below the title block. TOPS data pages include the TOPS number and page number centered at the page top and bottom, respectively. TOPS page numbers are the same as the modified TO page. If more than one TOPS page applies to a TO page, the second and subsequent pages are numbered “.1,” “.2.” etc. TOPS pages which were the result of a TCTO or which supersede other TOPS pages are so marked. Each TOPS page contains only data actually changed on the facing page in the TO, in the same location as on the facing page.

2.17.4 Interim Operational and Safety Supplements (IOS/ISS) (Figure 2-16, Figure 2-17 and Figure 2-18). IOSs and ISSs are issued within 48 hours after receipt of an Emergency recommended change (within 72 hours if the report concerns work stoppage), or within 40 calendar days after receipt of an Urgent recommended change. Additionally within AFMC, expedited Special Handling 252s (SH252s) will be implemented as IOS within 120 days from receipt by TOMA unless TO update can be accomplished within the 120 days. Until formal change or IOS is accomplished, the TODO will file SH252 as a private increment on electronic Tools (eTools) .

NOTE

ISSs and IOSs remain in effect until specifically incorporated, superseded or rescinded, no matter how long the period.

2.17.4.1 Data issued to a contractor-operated depot facility is issued as an interim operational or safety supplement. Interim updates against TOs distributed solely in eTO format are issued as RACs (paragraph 2.16.3). Interim updates against TOs distributed in HTML/XML eTO and paper format are issued as RACs (paragraph 2.16.3). Interim updates against TOs distributed in pdf eTO and paper format are issued as RACs (paragraph 2.16.3) or IOS/ISS. If issued as an IOS/ISS, the supplement will be appended, annotated and merged to form a complete eTO before distribution.

EXCEPTIONS: Early implementation recommend changes (RC) may be used to provide updated procedures for contractor use with TO 33K-1-70 and 33K-5 series TOs. Also, an IOS driven by AFMC 202 process may be used in lieu of the RACs and will be appended, annotated, and merged to form a complete eTO before distribution.

2.17.4.2 Emergency IOSs are issued when the using command is unable to achieve or maintain operational posture (MISSION ESSENTIAL), including field-level work stoppage. Urgent IOSs are issued for situations that reduce operational efficiency or probability of mission accomplishment, replacements for EPA Hazardous Materials (HAZMAT) and Ozone Depleting Substances (ODS), or cases that could result in over \$25,000 or 1000 man-hours annual savings to the Air Force. Expedited IOSs may be issued when there is a work stoppage at a Depot and a formal TO update cannot be completed in 120 days and an AF Form 202 if filed with the TO (see paragraph 5.6.15).

2.17.4.3 Emergency ISSs are issued when safety deficiencies WOULD result in a fatality or serious injury to personnel, or when extensive damage or destruction of equipment or property is involved. Urgent ISSs are issued when safety deficiencies COULD cause these conditions.

2.17.4.4 Supplement and RAC notification shall be sent using ETIMS notification function. TO Managers may also use email as a secondary method of notification. TODO shall acknowledge receipt within 2 hours for emergency notifications and as soon as possible during duty hours for urgent notifications. Acknowledgment shall be accomplished as directed in notification or by email if instructions are not provided. TO Managers will not accomplish initial distribution of Supplement or RAC “content” by email.

2.17.4.5 The same precedence is used for information addresses only if all addressees require the e-mail message with the same urgency. Addressees and e-mail message subject matter is reviewed by the originator to determine whether addressees not operating on 24-hour a day schedule require immediate delivery warranting recall of personnel to handle the e-mail message, or if delivery could be delayed until reopening of the station. If delay is acceptable, an appropriate notation should be made at the start of the e-mail message text.

TO 00-5-1

2.17.4.6 When formatted pages can be distributed with an interim supplement, temporary checklist/workcard pages may be included with the basic TO supplement. Temporary pages will be locally reproduced as needed. Requisitions cannot be submitted.

2.17.4.7 ISSs and IOSs affecting FMP TO checklists are issued against the basic TO rather than against the checklist. The FMM issues an ISS or IOS within 48 hours after receipt of MAJCOM approved and validated information. The interim supplement includes instructions authorizing write-in changes to the checklist, as well as changes to any affected integrated checklist.

2.17.4.8 When an ISS or IOS is issued to a missile system operations manual that affects checklist procedures, crewmembers may make write-in changes to the affected checklist provided it is specifically authorized by the supplement.

2.17.4.9 When an interim technical order (ITO) is published, it is assigned a PSN and indexed in the TO Catalog. ITOs cannot be ordered using the ETIMS. Instead, -WA-1 version will be downloaded from ETIMS or ITO will be obtained based on directions in increment catalog notes.

2.17.4.10 Except as indicated below, an ISS will be incorporated within 40 calendar days from the publication date by a TO change or revision. An IOS will be incorporated in the next scheduled formal TO change or revision, but not later than 365 calendar days from the publication date.

2.17.4.10.1 ISSs and IOSs issued to provide temporary instructions (for example, restrictions to operating parameters pending completion of a TCTO, use of prototype equipment for flight test, etc.) may remain active until completion of the task or project or for 30 months, whichever is shorter.

2.17.4.10.2 Temporary FMP checklist pages transmitted with ISSs and IOSs will be replaced by concurrent issue of a TO change or revision to both the FMP TO and the related checklist. The TO change or revision, as appropriate, is prepared after the FMM has validated and refined the contents of the interim, and has requested issuance.

2.17.5 Identifying Technical Publications Sheets (ITPS). See Figure 2-11. An ITPS is used to identify pertinent information associated with Commercial Off-The-Shelf (COTS) Manuals. Two types of supplements are used IAW MIL-PRF-32216 and MIL-STD-38784: The first is the ITPS Cover Page (see Figure 2-11) that is required for all COTS manuals accepted by the Air Force. The cover page provides all necessary information about the manual, to include manufacturer's data, the definition of the AF limits of releasability, and/or data rights. It is produced and distributed singly when no supplementation of the commercial manual is required. The cover page shall be posted immediately on top of the COTS manual title page (above the safety summary, if included). The second type of supplement is the Commercial Manual Supplement (CMS) (see Figure 2-11.1) that is included only when the COTS manual is deemed insufficient and supplemental information is required, based on a review of the COTS manual, in accordance with MIL-PRF-32216. The CMS serves as a routine supplement consisting of a title page, supplemental data, and if included, an optional LEP. The title page is formatted similar to the ITPS Cover Page and contains the same information concerning manufacturer's data, definition of the AF limits of releasability, and/or data rights information as the cover page. The CMS shall be posted directly behind the COTS manual. Both supplements are issued together in a change package when supplementation of the commercial manual is required (see Figure 2-11.1). Each ITPS shall contain the appropriate STINFO including distribution statement, export control and destruction statements, and the authority notice IAW MIL-STD-38784.

2.17.6 The COTS manual supplementation arrangement is as follows:

2.17.6.1 In front of manual:

2.17.6.1.1 ITPS cover page (always required) contains manufacturer's information, STINFO, classification, data rights, etc., and outline of supplemental data (if applicable), formatted IAW MIL-PRF-32216.

2.17.6.1.2 Safety summary (when used, in accordance with MIL-STD-38784).

2.17.6.2 COTS manual

2.17.6.3 Behind manual:

2.17.6.3.1 CMS title page (used only for rejected COTS manuals that require supplemental data IAW MIL-PRF-32216) consists of front matter containing manufacturer's information, STINFO, data rights, etc.; patterned after the ITPS cover page.

2.17.6.3.2 COTS supplemental information appended to bottom of CMS title page. Specific paragraphs containing changed data are numbered 1., 2., 3., etc.

NOTE

- When updates to supplemental information are issued following initial distribution of ITPS cover page, the replacement ITPS cover page will be issued with the replacement CMS page(s) as a package.
- The new cover page should be separated from the package and posted in front of the COTS manual and the new CMS page(s) posted behind the COTS manual.

2.17.6.3.3 Optional LEP. An optional LEP may be included with the CMS that reflects the information for the supplement as well as the COTS manual.

2.18 MAJCOM, BASE AND UNIT TECHNICAL ORDER SUPPLEMENTS.

These supplements adhere to standard format, page size and drilling requirements of the basic TO, but are published by the MAJCOM/Base Publications and Forms Office IAW standard AF publication policies. The preparing activity determines the quantity and distribution of the supplement. This includes updating supplements within 180 days after publication of a revised basic TO.

2.18.1 MAJCOM Supplements. The titles of MAJCOM MPTO supplements begin with the MAJCOM abbreviation, followed by the word “Supplement 1” or “Sup 1” and then the date (e.g., the AFSOC supplement to TO 00-5-1 is titled “AFSOC Sup 1, Dated 10 July 2013”). A single organization is assigned responsibility to ensure MPTO supplements address the requirements of all users. Once approved for publication, MAJCOM will append supplement to published MPTO and annotate/link to create a single merged file with supplement posted. (Reference MAJCOM/Base Field Users Guide found at <https://cs3.eis.af.mil/sites/OO-LG-TO-HP/default.aspx>). MAJCOM will then forward the merged file to the AF TOFST, who will then assign the TO number (on initial creation, i.e., 00-5-1-AFMC-WA-1), upload the file into the ETIMS repository and complete indexing in ETIMS required for deployment. When viewing the merged TO title page in ETIMS, a link to the supplement will be displayed, along with the publication date (see Figure 2-12). TODOs will be responsible for establishing subscription to their specific MAJCOM supplements.

2.18.1.1 MAJCOMs that do not require changes to their MPTO supplements following a revision of the basic TO, may digitally stamp their supplement as “Certified Current” (include the date) without requiring formal approval. This process is authorized for one basic TO revision cycle and providing there are no content or administrative changes that do not change the intent of supplemented information.

2.18.1.2 Base and Unit Supplements. Base and unit MPTO supplements adhere to the same requirements as MAJCOM supplements. The titles of base and unit MPTO supplements begin with the base/unit abbreviation, followed by the word “Supplement 1” or “Sup 1” and then the date (Table 2-1). Once approved for publication, Base/unit POC will append supplement to published MPTO and annotate/link to create a single merged file, with supplement posted. (Reference MAJCOM/Base Field Users Guide found at <https://cs3.eis.af.mil/sites/OO-LG-TO-HP/default.aspx>). Base/unit POC will then forward the merged file to the individual responsible for loading the merged file on the required Master eTools for distribution. The individual responsible for loading the merged file will then assign the TO number (Table 2-1), upload the file into the Master eTool(s) for deployment. When viewing the merged TO title page, in the C2 viewer, a link to the supplement will be displayed, along with the publication date (see Figure 2-12). TODOs will be responsible for establishing subscription to their specific base and unit supplements.

2.18.2 MAJCOM Supplements to Aircraft or Missile Inventory (-21) TOs. MAJCOMs supplement -21 TOs to show assets that are unique to a particular MDS and peculiar to the MAJCOM (AFI 21-103, Equipment Inventory, Status, and Utilization Reporting). The supplement is numbered in the same manner as a supplement to an MPTO.

SECTION IV TECHNICAL ORDER FRONT MATTER CONTENT

2.19 TITLE PAGES.

All TOs and TO updates, except for interim or commercial manual TOs, will have a title page formatted according to MIL-STD-38784 (Figure 2-12). In addition, when required, the TO may have a second title page, numbered T-2 (Figure 2- 13), to

TO 00-5-1

provide space for required warnings and notices. The date an update becomes effective will be included when this date is later than the update issue date. A supersedure notice will list all previously published updates included in the new TO increment. A supplement notice will show dependent and supporting publications when one cannot be used without the other. Digital TOs will either include a title “page” or include all required information, warnings and notices in an opening screen view. Release and distribution of TOs and other technical data is controlled to prevent unauthorized disclosure. The following notices and warnings are found on all preliminary and formal TO title (or T-2) pages when required by the TO contents:

2.19.1 Disclosure Notice. A disclosure notice is used on all classified and unclassified TOs approved for release to a foreign government, except those assigned Distribution Statement A (MIL-STD-38784). The disclosure notice will be on all classified and unclassified nuclear TOs.

2.19.2 Distribution Statement. All TOs include a distribution statement on the title page. The distribution statement provides critical information used in determining dissemination controls (see Chapter 7). The distribution statement identifies the authorized audience approved for receipt of the TO. It provides a reason that the TO is restricted from public release if applicable, contains the date of determination and identifies the Controlling DoD Office (CDO).

2.19.3 Export Control Warning Label. TOs that cannot be lawfully exported without the approval, authorization or license under U.S. export control laws include an export control warning label immediately following the distribution statement.

2.19.4 Disposition/Handling and Destruction Notice. All classified TOs and limited distribution unclassified TOs include a handling and destruction notice on the title page.

2.20 ABBREVIATED TITLE PAGES.

See Figure 2-14. For TOs of twenty pages or less, an abbreviated title page will be used and all updates will be issued as revisions, without an LEP.

2.21 LIST OF EFFECTIVE PAGES (LEP).

See Figure 2-15. All page-based TOs, revisions, changes and TO Page Supplements (TOPS) contain an LEP (Figure 2-15) reflecting the dates of the basic or revision and any changes, and the change number of each page within the manual. LEPs, commonly called “A pages”, follow the title and T-2 pages. The first LEP is numbered “A” with additional LEPs, if required, numbered sequentially through the alphabet in capital letters. Under the “Page Number” column, all of the TO pages are listed. Pages in unbroken numerical sequence are listed as “i -vi”, “1-1 - 1-8”, “2-1 - 2-16”, etc. Under the “Change No.” column, the change numbers for each page or series of pages are listed, such as 1, 2, 3. A zero (0) indicates a blank page or an original issue page or group of pages of the TO. The words “Deleted”, “Added”, or “Blank” are shown between affected page numbers and the change number when applicable. Page-oriented digital TOs will also include an LEP.

2.22 VERIFICATION STATUS PAGES (VSP).

VSPs will be included in PTOs and formal TOs containing unverified procedures. These pages will immediately follow the LEP and be formatted and numbered according to MIL-STD-38784. A WARNING shall be placed on the TO title page in accordance with MIL-STD-38784. VSPs must be reviewed to check the verification status before attempting to use any procedure. As procedures in a TO are verified, updates will be issued to revise the VSP, or delete it along with any verification-related warnings or notes once all procedures are verified. Digital TOs will also include a VSP or Verification Status screen.

Table 2-1. Local TO Title/Number Example

Supplement Title	Merged TO Number	Merged Books	Viewable in ETIMS
AFSOC Sup 1, 10 Jul 13	00-5-1-AFSOC-WA-1	Basic w/MAJCOM Supplement	YES
46 Test Wing Supplement 1, 10 Jul 13	00-5-1-46TW-WA-1	Basic w/Base Supplement	NO
8th Test Squadron Supplement 1, 10 Jul 13	00-5-1-8TS-WA-1	Basic w/Local Unit Supplement	NO
	00-5-1-AFMC-46TW-WA-1	Basic w/MAJCOM & Base Supplements	NO
	00-5-1-AFMC-8TS-WA-1	Basic w/MAJCOM & Unit Supplements	NO
	00-5-1-46TW-8TS-WA-1	Basic w/Base & Unit Supplements	NO
	00-5-1-AFMC-46TW-8TS- WA-1	Basic w/MAJCOM, Base & Unit Supplements	NO

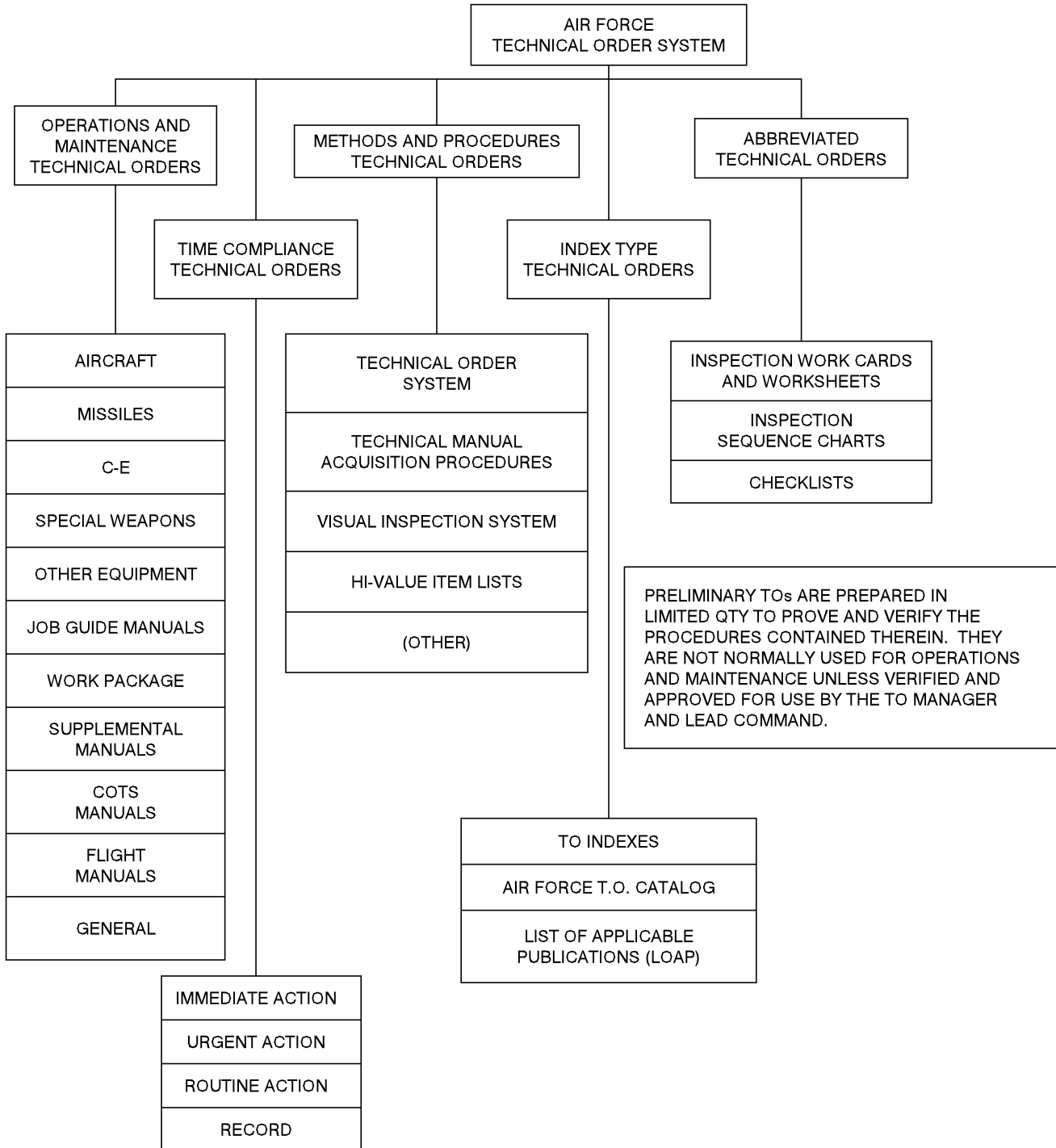

H8900028

Figure 2-1. Types of TO Publications

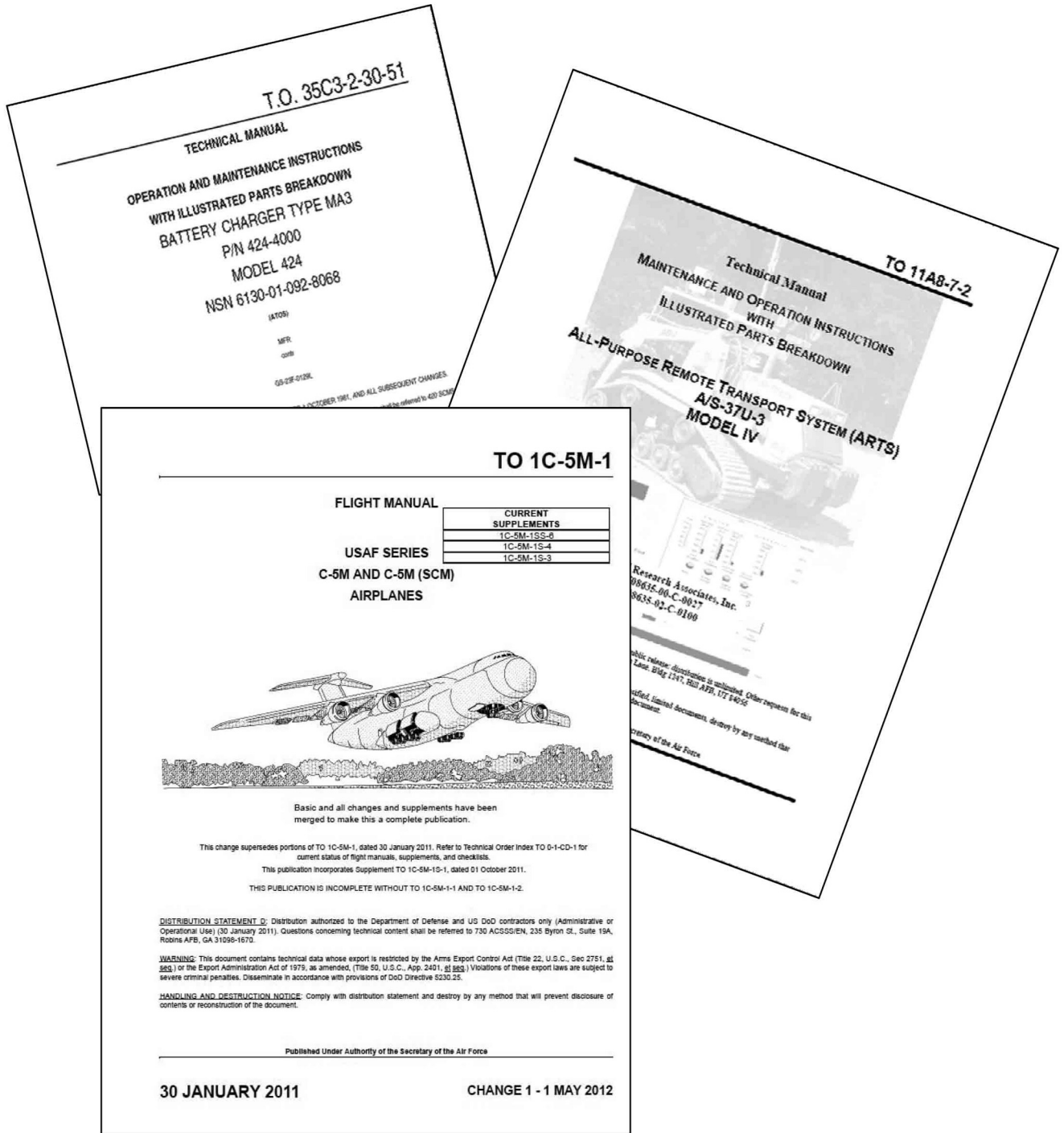

H8900029

Figure 2-2. Operations and Maintenance Technical Orders

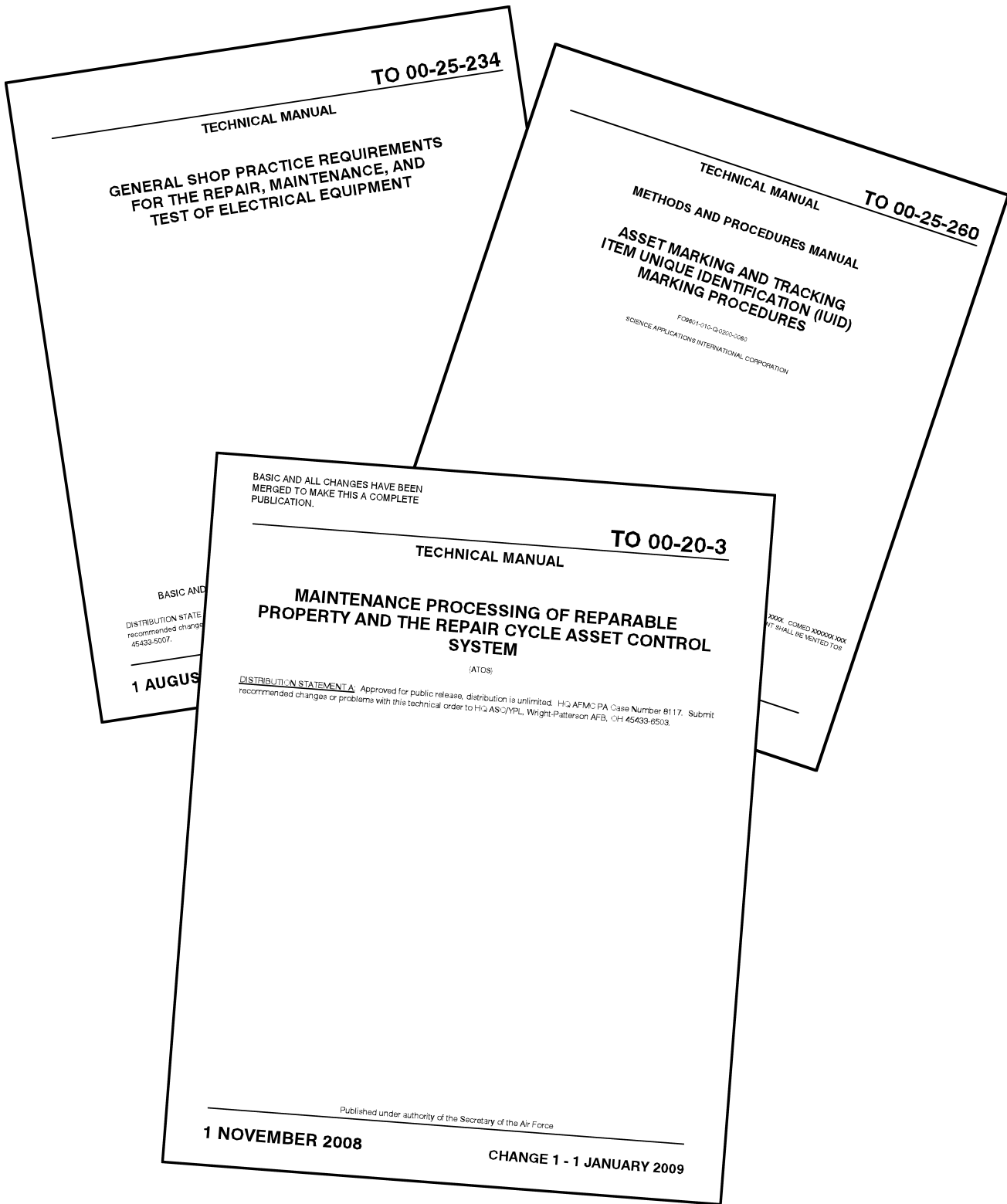

Figure 2-3. Methods and Procedures Technical Orders

H8800038

T.O. 1C-12F-2-1CL-1

CHECK LIST

**ORGANIZATIONAL
MAINTENANCE**

TO 00-25-172CL-1

TECHNICAL MANUAL

CHECKLIST

**CONCURRENT FUEL
SERVICING OF COMMERCIAL
CONTRACT CARGO AND
PASSENGER AIRCRAFT**

**APPLICABLE TO B-707, B-727, B-737,
B-747, B-757, B-767, B-777, DC-8,
DC-9, DC-10, L-1011, MD-11, MD-81,
MD-82, MD-83, MD-88, MD-90, AND AIRBUS
A300/A310/A318/A319/A320/A321/A330/A340/
A380**

AIRCRAFT

F09603-89-C-2904

SEPTEMBER 1989

30 SEPTEMBER 2003

This publication supplements TO 00-25-172.

**BASIC AND ALL CHANGES HAVE BEEN MERGED
TO MAKE THIS A COMPLETE PUBLICATION.**

DISTRIBUTION STATEMENT A - Approved for public release; distribution is unlimited. PA Case Number 05-08061. Submit recommended changes or problems with this Technical Order to 406 SCMS/GUEE, Robins AFB, GA 31096. Questions concerning technical content shall be referred to HQ AFMC/SE.

Published Under Authority of the Secretary of the Air Force

20 NOVEMBER 1989 CHANGE 13 - 16 JANUARY 2014

H8900032

Figure 2-4. Abbreviated Technical Orders - Checklists

TO 13B4-4-6WC-1

WORK CARDS

**AIR TRANSPORTABLE GALLEY/LAVATORY (ATGL)
INSPECTION REQUIREMENTS**

SERV-AIR, INC.
DAAB07-92-Z-0506

BASIC AND ALL CHANGES HAVE BEEN MERGED TO MAKE THIS A COMPLETE PUBLICATION.

DISCLOSURE NOTICE - This information is furnished upon the condition that it will not be released to another nation without the specific authority of the Department of the Air Force of the United States, that it will be used for military purposes only, that individual or corporate rights originating in the information, whether patented or not, will be respected, that the recipient will report promptly to the United States, any known or suspected compromise, and that the information will be provided substantially the same degree of security afforded it by the Department of Defense of the United States. Also, regardless of any other markings on the document, it will not be downgraded or declassified without written approval of the originating United States agency.

DISTRIBUTION STATEMENT B - Distribution authorized to U.S. Government Agencies only (Administrative or Operational Use) (30 April 1995). Other requests for this document shall be referred to 406 SCMS/GUEE, Robins AFB, GA 31098. Questions concerning technical content shall be referred to 404 SCMS/GUEEA.

WARNING - This document contains technical data whose export is restricted by the Arms Export Control Act (Title 22, U.S.C., Sec 2751, et seq.) or the Export Administration Act of 1979, as amended, Title 50, U.S.C., App. 2401, et seq. Violations of these export laws are subject to severe criminal penalties. Disseminate in accordance with provisions of DoD Directive 5230.25.

HANDLING AND DESTRUCTION NOTICE - Comply with distribution statement and destroy by any method that will prevent disclosure of contents or reconstruction of the document.

Published Under Authority of the Secretary of the Air Force

30 APRIL 1995

CHANGE 3 - 30 APRIL 2013

CARD NO. 1-002		WORK AREA(S) 1		TYPE MECH RQR APG	MECH NO.	CARD TIME 01:02	PUBLICATION NUMBER 13B4-4-6WC-1			CHANGE NO. 1
MAN MIN	WORK AREA	WORK UNIT CODE		PERIODIC	INSPECTION REQUIREMENTS	ELECTRICAL POWER OFF	SERVICE	FIGURE	CARD NO. 1-002	
		SYS	SUB							
037	1	49	GAO	GALLEY AREA 1. REMOVE THE FOLLOWING ITEMS IAW TO 13B4-4-1: A. OVENS. B. COFFEE MAKERS. C. REFRIGERATORS. D. CONTROL PANEL. 2. OVEN CAVITIES: A. FOR CRACKS, CHIPPED OR PEELING PAINT, DENTS, CORROSION, LOOSE OR MISSING SCREWS, AND CLEANLINESS. B. BONDING BRACKETS FOR SECURITY AND LOOSE OR MISSING HARDWARE. C. SCREENS FOR DENTS, DISTORTION, AND LOOSE OR MISSING SCREWS. D. SCREEN MOUNTS FOR CRACKS AND LOOSE OR MISSING RIVETS AND NUTPLATES. E. GUIDE RAILS FOR CRACKS, DISTORTION, AND LOOSE OR MISSING SCREWS. F. ELECTRICAL CONNECTOR AND WIRING HARNESS FOR EVIDENCE OF OVERHEATING (INSULATION DISCOLORATION OR DETERIORATION) AND SECURITY. G. LIGHT BALLAST AND BRACKET FOR SECURITY AND LOOSE OR MISSING SCREWS. H. LIGHT BALLAST WIRING HARNESS FOR SIGNS OF OVERHEATING (INSULATION DISCOLORATION OR DETERIORATION) AND CLAMPS FOR SECURITY. L. LAVATORY ACCESS PANEL FOR DENTS, DISTORTION, AND LOOSE OR MISSING HARDWARE. J. OVEN DOOR BUMPER FOR LOOSE OR MISSING RIVETS. K. MAIN POWER ELECTRICAL CABLE FOR EVIDENCE OF OVERHEATING (INSULATION DISCOLORATION AND DETERIORATION) AND CLAMPS FOR SECURITY.						
010	1	49	GAO							
CARD NO. 1-002		WORK AREA(S) 1		TYPE MECH RQR APG	MECH NO.	CARD TIME 01:02	PUBLICATION NUMBER 13B4-4-6WC-1			CHANGE NO. 1

H8900033

Figure 2-5. Abbreviated Technical Orders - Inspection Workcards

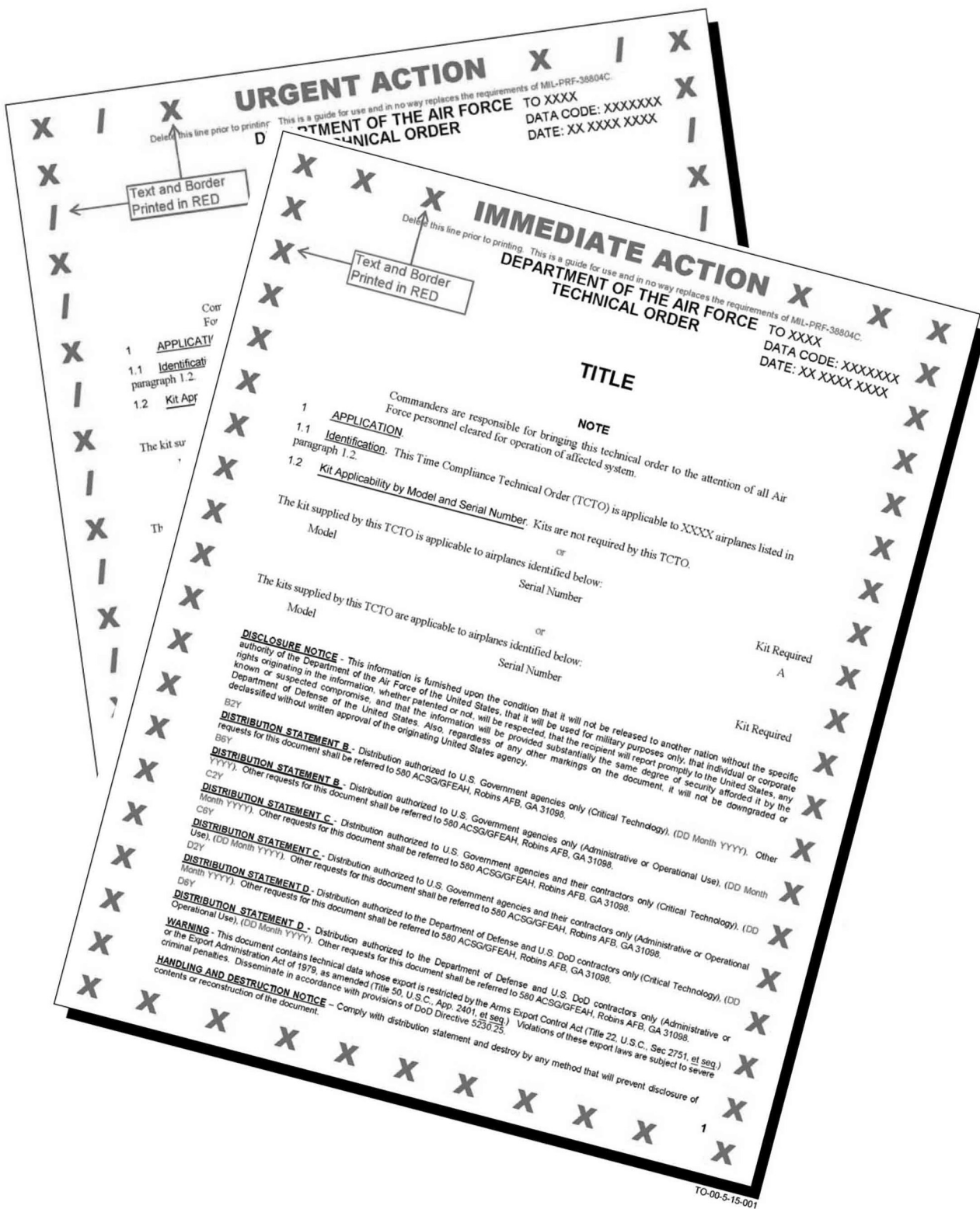
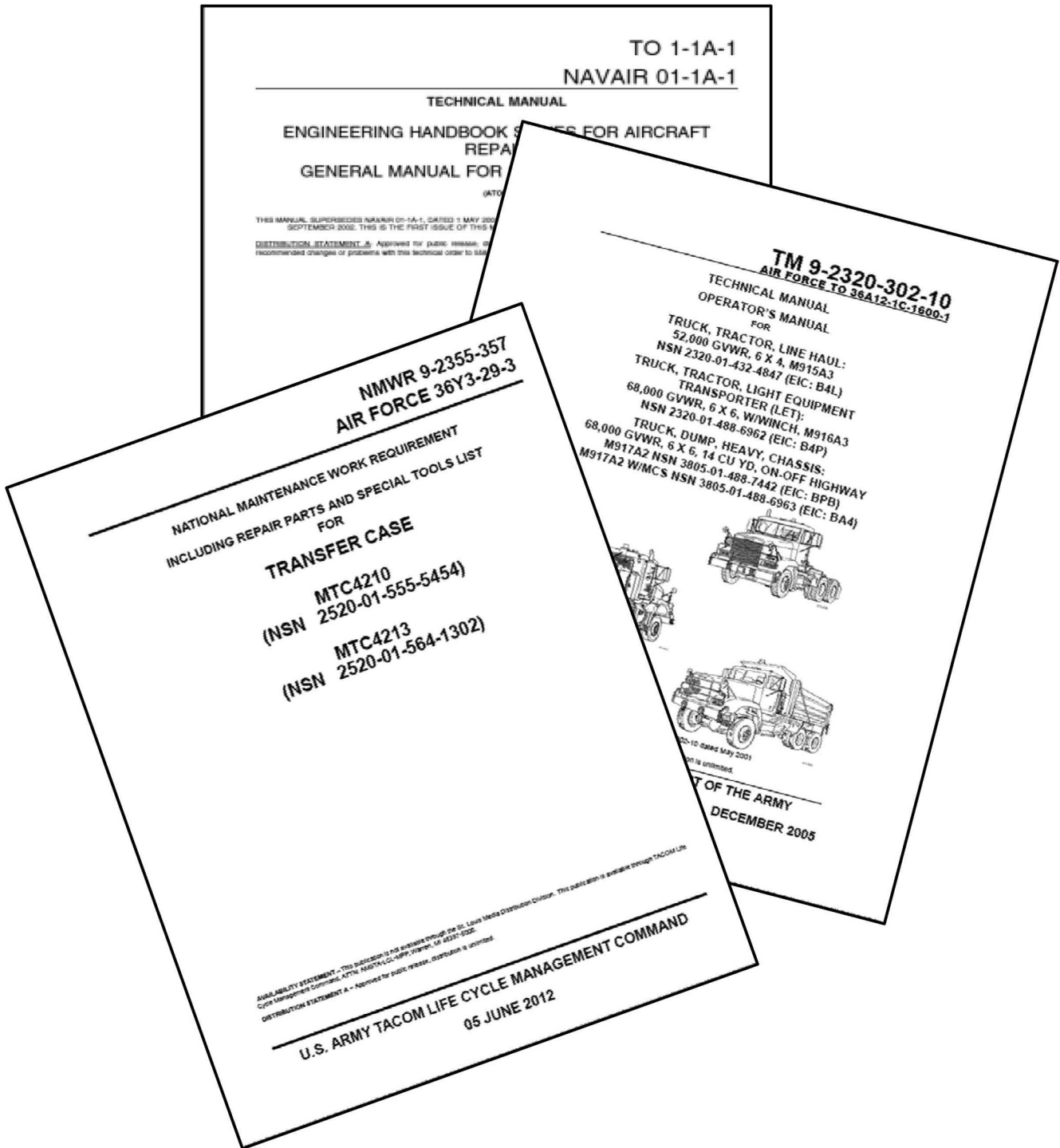

Figure 2-6. Time Compliance Technical Orders



H1102871

Figure 2-7. Joint-Use Publications

TO 5A7-3-47-3

**PRELIMINARY
TECHNICAL MANUAL**

WARNING

To prevent injury to personnel or damage to equipment, extreme caution should be exercised when using these procedures. Before use, refer to the Verification Status Page for additional instructions.

OPERATION AND MAINTENANCE INSTRUCTIONS

TO 5A7-3-47-3

TECHNICAL MANUAL

OPERATION AND MAINTENANCE INSTRUCTIONS

DEPOT

CENTRAL AIR DATA COMPUTER

PART NO. 8518930-901

HONEYWELL INC.
(Manual prepared by Lockheed Martin Corporation)

P84086 96 D 8902
P43639 97-D 8910

DISTRIBUTION STATEMENT

Distribution authorized to Department of Defense (DOD) components only (Direct Military Support). Other requests for this document shall be referred to OOO-ALC/LGFB, 6071 Gum Ln, Hill AFB, UT 84056-5826.

EXPORT CONTROL WARNING

WARNING: This document contains technical data whose export is restricted by the Arms Export Control Act (Title 22, U.S.C. Sec. 2751 et seq) or Export Administration Act of 1979 as amended (Title 50, U.S.C. app 2401 et seq). Violation of these export control laws is subject to severe criminal penalties. Disseminate in accordance with provisions of AFI 61-204.

HANDLING AND DESTRUCTION NOTICE

For unclassified, limited documents, destroy by any method that will prevent disclosure of contents or reconstruction of the document.

SUPERSEDURE NOTICE

This manual supersedes Preliminary T.O. 5A7-3-47-3, dated 15 September 1998.

Published under authority of the Secretary of the Air Force.

15 NOVEMBER 2000

**COMPUTER
0-901**

d to US Government agencies
ep 93). Other requests for this
al System Division (ASD), F-16
tics, Wright-Patterson AFB, OH

is restricted by the Arms Export Control
Act of 1979, as amended, Title 50, U.S.C.,
evere criminal penalties. Disseminate in

th the distribution statement and destroy
ruction of the document.

of the Air Force.

15 SEPTEMBER 1993

H8900037

Figure 2-8. Preliminary Technical Order and Formal Replacement

STATUS PAGE

This page is published with each formal Safety and Operational Supplement for flight manual program publications. It contains a listing of the affected flight manual and its related supplements and checklists current on the date of this publication. Changes or Revisions in production are shown in parentheses. ()*.

AIRCREW FLIGHT MANUAL	DATE	CHANGE NO. AND DATE
T.O. 1C-135(R)S-1	15 Oct 89	44 10 Oct 04

FLIGHT CREW CHECKLISTS	DATE	CHANGE NO. AND DATE
T.O. 1C-135(R)S-1CL-1	10 Oct 98	17 10 Oct 04
T.O. 1C-135(R)S-1CL-2	15 Oct 89	30 10 Oct 04
T.O. 1C-135(R)S-1CL-4	10 Feb 98	8 10 Jun 04

SAFETY AND OPERATIONAL SUPPLEMENTS	DATE	SHORT TITLE
1S-21(I)	20 Nov 04	Hard Landings
1S-22(I)	11 Dec 04	ARR System Purge
1S-23	15 Jan 05	IFQ/CGS Fuel System

*Estimated distribution date ---

H9262613

Figure 2-9. Example of an FMP Status Page

TO XX-XXX-XX-XTP-1

**TECHNICAL ORDER PAGE SUPPLEMENT
TECHNICAL MANUAL
STORAGE AND MAINTENANCE INSTRUCTIONS**

**BAROSTAT LOCK INITIATOR
PART NO. 90167-3**

USAF SERIES F-1A AIRCRAFT

This TOPS supplements TO XX-XXX-XX-X dated 4 September 1992. Change 2 dated 12 April 1993. Reference to this supplement will be made on the title page of the basic manual by personnel responsible for maintaining the manual in current status.

COMMANDERS ARE RESPONSIBLE FOR BRINGING THIS SUPPLEMENT TO THE ATTENTION OF ALL
AFFECTED PERSONNEL

Distribution Statement C. Distribution authorized to US Government agencies and their contractors: Administrative or Operational Use: 4 September 1992. Other requests for this document shall be referred to HQ ESC/AV-2S, Wright-Patterson AFB, OH 45433-5001.

WARNING - This document contains technical data whose export is restricted by the Arms Export Control Act (Title 22, U.S.C. SEC 2751, et seq.) or the Export Administration Act of 1979, as amended, Title 50, U.S.C., App 2401 et seq. Violations of these export laws are subject to severe criminal penalties. Disseminate in accordance with provisions of DoD Directive 5230.25.

HANDLING AND DESTRUCTION NOTICE - Comply with distribution statement and destroy by any method that will prevent disclosure of contents or reconstruction of the document.

Published under authority of the Secretary of the Air Force

4 MARCH 1994

LIST OF EFFECTIVE PAGES

NOTE: This TOPS contains supplementary information. Text pages do not supersede pages of basic TO but will be inserted facing the amended page. Total number of effective TOPS pages is 3.

Page No.	Page No.	Page No.	Page No.	Page No.
4-16				
5-14				
5-17				

H8900035

Figure 2-10. TO Page Supplements (TOPS)

IDENTIFYING TECHNICAL PUBLICATION SHEET FOR COMMERCIAL MANUAL

THIS PUBLICATION SUPERSEDES TO 5E6-2-58-3, DATED 15 AUGUST 2011, IN ITS ENTIRETY.

PURPOSE: This technical publication is issued for the purpose of identifying and authorizing the following commercial manual for Air Force use.

MANUFACTURER: ELDON PO Box 100
4500 Whirlwind Rd
McGaheysville, VA, 22840
CONTRACT NO: F12345-00-C-0123
REQUISITION NO: NA
EQUIPMENT: N1 Rotor Percent of RPM Indicator 9-201-01
TITLE: Overhaul Instructions with Illustrated Parts Breakdown - N1 Rotor Percent of RPM
Indicator - Part Number 9-201-01
ADDITIONAL IDENTIFICATION: ELDON Document 367510
DATE: 2014-11-15

DISCLOSURE NOTICE – This information is furnished upon the condition that it will not be released to another nation without the specific authority of the Department of the Air Force of the United States, that it will be used for military purposes only, that individual or corporate rights originating in the information, whether patented or not, will be respected, that the recipient will report promptly to the United States, any known or suspected compromise, and that the information will be provided substantially the same degree of security afforded it by the Department of Defense of the United States. Also, regardless of any other markings on the document, it will not be downgraded or declassified without written approval of the originating United States agency.

DISTRIBUTION STATEMENT D – Distribution authorized to Department of Defense and U.S. DoD contractors only, Administrative or Operational Use, 15 December 2014. Refer other requests for this document to 123 ABCD/VXYZ, Tinker AFB, Oklahoma 73000-0001

WARNING - This document contains technical data whose export is restricted by the Arms Export Control Act (Title 22, U.S.C. SEC 2751, et seq.) or the Export Administration Act of 1979, as amended, Title 50, U.S.C., App 2401, et seq. Violations of these export laws are subject to severe criminal penalties. Disseminate in accordance with provisions of DoD Directive 5230.25.

HANDLING AND DESTRUCTION NOTICE – Destroy by any method that will prevent disclosure of contents or reconstruction of the document.

Published under authority of the Secretary of the Air Force

NOTICE: Reproduction for non-military use of the information or illustrations contained in this publication is not permitted. The policy for military reproduction is established for the Army in AR 38-4, for the Navy and Marine Corps in OPNAVINST 5510.1, and for the Air Force in AFPD 34-1.

H9262611

Figure 2-11. Identifying Technical Publication Sheet (ITPS) Cover Page for COTS Manuals

TO 5A-2-4-6-3K
15 MAY 2012

COMMERCIAL MANUAL SUPPLEMENT TECHNICAL MANUAL

THIS REVISION SUPERSEDES TO 5A-2-4-6-3I, DATED 15 AUGUST 2011 IN ITS ENTIRETY.

PURPOSE: This technical publication is issued for the purpose of identifying and authorizing the following commercial manual for Air Force use.

MANUFACTURER: Benton Harbor Aviation Tools Group

Kalamazoo, MI (Code: 00001)

CONTRACT NO: F12345-70-C-0123

EQUIPMENT: Torque Adapter
180000-1

TITLE: Overhaul Instructions (with Parts Breakdown), Torque Adapter 180000-1

ADDITIONAL IDENTIFICATION: Publication No. ATA 60-1

DATE: 1 July 2003, Revision 1-17 April 2011

DISCLOSURE NOTICE - This information is furnished upon the condition that it will not be released to another nation without the specific authority of the Department of the Air Force of the United States, that it will be used for military purposes only, that individual or corporate rights originating in the information, whether patented or not, will be respected, that the recipient will report promptly to the United States, any known or suspected compromise, and that the information will be provided substantially the same degree of security afforded it by the Department of Defense of the United States. Also, regardless of any other markings on the document, it will not be downgraded or declassified without written approval of the originating United States agency.

DISTRIBUTION NOTICE X - Distribution authorized to U.S. Government Agencies and private individuals or enterprises eligible to obtain export-controlled technical data in accordance with DoDD 5230.25, 15 November 1996. Controlling DoD office is WXYZ, Tinker AFB, Oklahoma 73000-0001.

WARNING - This document contains technical data whose export is restricted by the Arms Export Control Act (Title 22, U.S.C. 2751 *et seq.*) or the Export Administration Act of 1979, as amended, Title 50, U.S.C., App. 2401, *et seq.* Violation of these export-control laws is subject to severe criminal penalties. Dissemination of this document is controlled under DoD Directive 5230.25.

HANDLING AND DESTRUCTION NOTICE - Destroy by any method that will prevent disclosure of contents or reconstruction of the document

Published under authority of the Secretary of the Air Force

NOTICE: Reproduction for non-military use of the information or illustrations contained in this publication is not permitted. The policy for military reproduction is established for the Army in AR 38-4, for the Navy and Marine Corps in OPNAVINST 5510.1, and for the Air Force in AFPD 34-1.

1 Page i/ii TOC - After Chapter 12 Illustrated Parts List - ADD as follows:

ADD: Appendix A Item Unique Identification (IUID) Required Information.....(PAGE) A-1

2 Page 101 - ADD new sentence to paragraph 2. as follows:

Refer to paragraph 4 A. for Item Unique Identification (IUID) marking instructions and Appendix A, Table A-1. for identification of parts to be marked.

3 Page 201/202, Add warning prior to text as follows:

WARNING

Compressed air used for cleaning purposes shall not exceed 30 psi and then shall be used only when goggles or face shields are used for personnel eye protection.

4 Page 301 - ADD new paragraph 4.A. as follows:

4.A ITEM UNIQUE IDENTIFICATION (IUID).

Visually inspect the identification plate/label/item for the Unique Item Identifier (UII) marking. If present, visually inspect for damage to the symbol. Ensure readability by using hand-held electronic reader, if symbol is not present or damaged mark/restore. REF: Drawing 200123456, Appendix A, Table A-1. of this T.O. for identification of parts to be marked, T.O. 00-25-260, and MIL-STD-130.

G1600524

Figure 2-11.1. Commercial Manual Supplement (CMS) Change Package for COTS Manuals (Sheet 1 of 3)

TO 5A-2-4-6-3K

5 Page 401, Section 5, Paragraph C.; Change as follows:

C INSTRUCTIONS FOR HANDLING DIODES AND TRANSISTORS.

CAUTION

Diodes and transistors can be damaged if correct procedures are not observed when handling them. Proper methods are necessary to prevent damage caused by excessive heat, surge currents, and excessive peak inverse voltage. Mistakes that rarely cause electron tube burnout usually permanently damage a diode or transistor. The following paragraphs outline methods of preventing excessive heat and surge currents.

6 Page 701, Section 8, Paragraph A.; Delete paragraph A.

7 Remove the attached Identifying Publication Cover Page and insert the page ahead of the current commercial title page. Post this supplement in the back of the manual as required by TO 00-5-1.

G1600525

Figure 2-11.1. Commercial Manual Supplement (CMS) Change Package for COTS Manuals (Sheet 2)

IDENTIFYING TECHNICAL PUBLICATION SHEET FOR COMMERCIAL MANUAL

THIS PUBLICATION SUPERSEDES TO 5A-2-4-6-3, DATED 15 AUGUST 2011 IN ITS ENTIRETY.

PURPOSE: This technical publication is issued for the purpose of identifying and authorizing the following commercial manual for Air Force use.

MANUFACTURER: Benton Harbor Aviation Tools Group

Kalamazoo, MI (Code: 00001)

CONTRACT NO: F12345-70-C-0123

EQUIPMENT: Torque Adapter
180000-1

TITLE: Overhaul Instructions (with Parts Breakdown), Torque Adapter 180000-1

ADDITIONAL IDENTIFICATION: Publication No. ATA 60-1

DATE: 1 July 2003, Revision 1-17 April 2011

DISCLOSURE NOTICE - This information is furnished upon the condition that it will not be released to another nation without the specific authority of the Department of the Air Force of the United States, that it will be used for military purposes only, that individual or corporate rights originating in the information, whether patented or not, will be respected, that the recipient will report promptly to the United States, any known or suspected compromise, and that the information will be provided substantially the same degree of security afforded it by the Department of Defense of the United States. Also, regardless of any other markings on the document, it will not be downgraded or declassified without written approval of the originating United States agency.

DISTRIBUTION NOTICE X - Distribution authorized to U.S. Government Agencies and private individuals or enterprises eligible to obtain export-controlled technical data in accordance with DoDD 5230.25, 15 November 1996. Controlling DoD office is LIIS, Tinker AFB, Oklahoma 73145-3029.

WARNING - This document contains technical data whose export is restricted by the Arms Export Control Act (Title 22, U.S.C. 2751 *et seq.*) or the Export Administration Act of 1979, as amended, Title 50, U.S.C., App. 2401, *et seq.* Violation of these export-control laws is subject to severe criminal penalties. Dissemination of this document is controlled under DoD Directive 5230.25.

HANDLING AND DESTRUCTION NOTICE - Destroy by any method that will prevent disclosure of contents or reconstruction of the document

Published under authority of the Secretary of the Air Force

NOTICE: Reproduction for non-military use of the information or illustrations contained in this publication is not permitted. The policy for military reproduction is established for the Army in AR 38-4, for the Navy and Marine Corps in OPNAVINST 5510.1, and for the Air Force in AFPD 34-1.

SUPPLEMENTAL DATA

LIST OF AFFECTED PAGES IN BASIC MANUAL.

i/ii (TOC)	701	706	718	1106
101	702	707	719	1107
201/202	703	708	901/902	1108
301	704	716	1001	
401	705	717	1104	

SUPPLEMENTARY INFORMATION. The information contained in the above identified commercial manual is supplemented as follows:

- a. Table of Contents
- b. Section 5
- c. Section 8

G1600526

Figure 2-11.1. Commercial Manual Supplement (CMS) Change Package for COTS Manuals (Sheet 3)

TECHNICAL MANUAL

AFMC Supplement 1, 8 Oct 2009

AF TECHNICAL ORDER SYSTEM

(ATOS)

THIS PUBLICATION SUPERSEDES TO 00-5-1, DATED 1 OCTOBER 2008.

DISTRIBUTION STATEMENT A: Approved for public release; distribution is unlimited. HQ AFMC PA Case Number 04-318. Submit recommended changes or problems with this technical order to OC-ALC/ENGLA, Bldg 3, Suite 205, Tinker AFB OK 73145-9147.

Published under authority of the Secretary of the Air Force.

15 AUGUST 2009

H1102872

Figure 2-12. Example of Merged TO Supplement View on Title Page of TO

TO 1F-16CG-2-31JG-00-1

DISCLOSURE NOTICE

This information is furnished upon the condition that it will not be released to another nation without the specific authority of the Department of the Air Force of the United States, that it will be used for military purposes only, that individual or corporate rights originating in the information, whether patented or not, will be respected, that the recipient will report promptly to the United States, any known or suspected compromise, and that the information will be provided substantially the same degree of security afforded it by the Department of Defense of the United States. Also, regardless of any other markings on the document, it will not be downgraded or declassified without written approval of the originating United States Agency.

DISTRIBUTION STATEMENT

Distribution is authorized to Department of Defense (DOD) components only (Direct Military Support). Other requests for this document shall be referred to ASC/YPL, Wright-Patterson AFB, OH 45433-6503.

EXPORT CONTROL NOTICE

WARNING: This document contains technical data whose export is restricted by the Arms Export Control Act (Title 22, U.S.C. Sec. 2751 et seq) or the Export Administrative Act of 1979 as amended (Title 50, U.S.C. app. 2401 et seq). Violations of these export laws are subject to severe criminal penalties. Disseminate in accordance with provisions of AFR 80-34.

HANDLING AND DESTRUCTION NOTICE

Comply with distribution statement and destroy by any method that will prevent disclosure of contents or reconstruction of the document.

T-2 Change 9

H9400003

Figure 2-13. Example of a T-2 Page

TECHNICAL MANUAL
**INSPECTION AND PREVENTIVE MAINTENANCE
PROCEDURES FOR CLASSIFIED STORAGE CONTAINERS**

(ATOS)

THIS PUBLICATION SUPERSEDES TO 00-20F-2 DATED 19 OCTOBER 2000.

DISTRIBUTION STATEMENT - Approved for public release; distribution is unlimited.

Published under authority of the Secretary of the Air Force

9 MAY 2003**1. PURPOSE.**

The purpose of this manual is to establish a minimum procedure for inspection and preventive maintenance of filing cabinets authorized for use in storing classified material.

2. SCOPE.

The procedure established herein is applicable to those filing cabinets which satisfy the minimum security requirements established by DOD 5200.1-R/AFI 131-401.

3. DEFINITIONS.

a. "Security type equipment" as used herein refers to approved security containers and other file cabinets authorized for use in storing classified material.

b. "Approved Security Containers" as used herein refers specifically to those file cabinets which comply with the test requirements of current Federal Specifications. These cabinets may be identified by a label imprinted "General Services Administration Approved Security Container" affixed to lock drawer or attached to upper front part of the cabinet.

c. "Approved vault doors and their built-in locking mechanism" refers to doors that are mounted to vaults not constructed as a unit, therefore, not meeting the criteria of either of above definitions. When approved, doors are mounted to vaults constructed in accordance with civil engineering guidance.

4. RESPONSIBILITIES.

a. Responsibility for procedures outlined in this technical order will be assigned to personnel authorized by base commander. Repair, servicing, or preventive maintenance of this equipment will be accomplished only by a locksmith or other qualified personnel who have been the subject of a favorable National Agency Check prior to assignment to such duties. For US military personnel, an Entrance National Agency Check satisfies this requirement. See AFI 131-501, "USAF Personnel Security Program." When such service is provided on a contract basis, the owner/user submits through command channels a request to submit a National Agency Check (NAC) according to AFI 131-501. If access to classified information by the contractor is required to perform the service, the provisions of DOD 5220.22-R, Industrial Security Regulation, apply.

b. Preventive maintenance and inspection requirements stated in this technical order will be accomplished every five years for safes and every two years for vaults by qualified personnel in above paragraph.

c. Custodian of repositories for classified material is responsible for insuring that access to classified contents of such containers is not permitted to personnel performing repair, servicing, preventive maintenance, and inspection functions.

d. Each approved security container custodian will be adequately trained and instructed in operation of each individual container for which he is responsible. This training will be conducted by locksmiths or other personnel who are qualified as to technical construction, operation, maintenance,

H0315500

Figure 2-14. Example of an Abbreviated Title Page

T.O. 15A8-5-64-8-1

INSERT LATEST CHANGED PAGES. DESTROY SUPERSEDED PAGES.

LIST OF EFFECTIVE PAGES

NOTE: The portion of the text affected by the changes is indicated by a vertical line in the outer margins of the page. Changes to illustrations are indicated by miniature pointing hands. Changes to wiring diagrams are indicated by shaded areas.

Dates of issue for original and changed pages are:

Original 0 15 July 1976 Change 3 1 February 1984
 Change 1 15 March 1983 Change 4 1 January 1989
 Change 2 15 September 1983 Change 5 1 September 1994

TOTAL NUMBER OF PAGES IN THIS PUBLICATION IS 234, CONSISTING OF THE FOLLOWING:

Page No.	*Change No.	Page No.	*Change No.	Page No.	*Change No.
Title	5	3-99 - 3-135	2		
A	5	3-136 Blank	2		
a	4	4-1	4		
b Blank	4	4-2 Blank	4		
i - ii	4	Glossary 1 - Glossary 2	4		
1-1	3				
1-2	4				
1-3	2				
1-4 Blank	2				
2-1	4				
2-2	2				
3-1 - 3-2	5				
3-3 - 3-4	1				
3-4A - 3-4B	3				
3-4C - 3-4H	4				
3-5	4				
3-6	2				
3-6A - 3-6B	2				
3-7 - 3-8	2				
3-9 - 3-10	4				
3-10A	2				
3-10B	4				
3-10C - 3-10D	2				
3-11 - 3-66	0				
3-66A - 3-66H	2				
3-66J - 3-66N	2				
3-66P - 3-66V	2				
3-66W	4				
3-66X	2				
3-66X1	4				
3-66X2 Blank	4				
3-66Y	3				
3-66Z	2				
3-66AA - 3-66AH	2				
3-66AJ - 3-66AN	2				
3-66AP - 3-66AZ	2				
3-66BA - 3-66BH	2				
3-66BJ - 3-66BN	2				
3-66BP - 3-66BT	2				
3-67 - 3-83	0				
3-84 - 3-89	2				
3-90 - 3-98	0				

*Zero in this column indicates an original page

A Change 5

USAF
H9404286

Figure 2-15. Example of a List of Effective Pages

From: (TO Manager E-mail address)
Sent: (Date and time generated by E-mail application, e.g., Tuesday, January 3, 2011 6:01 AM)
To: (E-mail distribution list based upon JCALS ID subscriber list)
Subject: INTERIM (SAFETY or OPERATIONAL) SUPPLEMENT T.O. (Supplement Number), DATED (Date)

1. "THIS PUBLICATION SUPPLEMENTS TO (number) DATED (date) TITLE (title of basic TO). (When applicable enter). "THIS MESSAGE SUPERSEDES INTERIM (SAFETY or OPERATIONAL) SUPPLEMENT TO (supplement number), DATED (date). A SUITABLE REFERENCE TO THIS SUPPLEMENT WILL BE MADE ON THE TITLE PAGE OF THE BASIC PUBLICATION. COMMANDERS ARE RESPONSIBLE FOR BRINGING THIS SUPPLEMENT TO THE ATTENTION OF ALL AFFECTED AIR FORCE PERSONNEL. MAJCOMs, FOAs AND DRUs ARE RESPONSIBLE FOR FORWARDING THIS (ISS or IOS) TO SUBORDINATE UNITS NOT ADDRESSED IN THIS E-MAIL.
2. DISTRIBUTION STATEMENT (IAW DODD 5320.24 and AFI 61-204).
3. (When applicable enter) DISCLOSURE NOTICE (IAW MIL-STD-38784).
4. (When applicable enter) EXPORT CONTROL WARNING (IAW DODD 5320.24 and AFI 61-204).
5. (When applicable enter) HANDLING AND DESTRUCTION NOTICE (IAW MIL-STD-38784).
6. PURPOSE: THIS SUPPLEMENT IS ISSUED TO AMEND THE BASIC PUBLICATION.
7. INSTRUCTIONS:
 - A. PAGE (number). PARAGRAPH (number) IS (specific action, e.g., "amended to read", "deleted in its entirety", "amended to add the following paragraph", etc.)
 - B. PAGE (number). PARAGRAPH (number) IS (etc.)
8. THE TECHNICAL CONTENT MANAGER FOR THIS SUPPLEMENT IS (name, office symbol, Commercial/DSN phone number, e-mail address). THE TO MANAGER FOR THIS SUPPLEMENT IS (name, office symbol, Commercial/DSN phone number, e-mail address).
THE END

NOTE: If the IOS/ISS is released as an attachment to the transmitting e-mail or through a restricted access site, the "Subject" through "The End" must be included in the attachment. If the supplement contains graphics, the supplement and graphics must be attached to the transmitting e-mail, if e-mail is used.

H1102537

Figure 2-16. Format for Publications of Interim Safety/Operational Supplements (Except FMP Publication)

From: (Flight Manual Manager E-mail address)
 Sent: (Date and time generated by E-mail application, e.g., Tuesday, January 3, 2011 6:01 AM)
 To: All affected units.
 Subject: INTERIM (SAFETY or OPERATIONAL) SUPPLEMENT T.O. (Supplement Number), DATED (Date)

1. "THIS PUBLICATION SUPPLEMENTS FLIGHT MANUAL (number) DATED (date) TITLE (title of basic TO). (When applicable enter). "THIS MESSAGE SUPERSEDES INTERIM (SAFETY or OPERATIONAL) SUPPLEMENT TO (supplement number), DATED (date). A SUITABLE REFERENCE TO THIS SUPPLEMENT WILL BE MADE ON THE TITLE PAGE OF THE BASIC PUBLICATION. COMMANDERS ARE RESPONSIBLE FOR BRINGING THIS SUPPLEMENT TO THE ATTENTION OF ALL AFFECTED AIR FORCE PERSONNEL. MAJCOMs, FOAs AND DRUs ARE RESPONSIBLE FOR FORWARDING THIS (ISS or IOS) TO SUBORDINATE UNITS NOT ADDRESSED IN THIS E-MAIL.
2. DISTRIBUTION STATEMENT (IAW DODD 5320.24 and AFI 61-204).
3. (When applicable enter) DISCLOSURE NOTICE (IAW MIL-STD-38784).
4. (When applicable enter) EXPORT CONTROL WARNING (IAW DODD 5320.24 and AFI 61-204).
5. (When applicable enter) HANDLING AND DESTRUCTION NOTICE (IAW MIL-STD-38784).
6. NOTICE TO AIRCREWS: WRITE THE NUMBER OF THIS SUPPLEMENT ALONGSIDE THE CHANGED PORTION OF THE FLIGHT MANUAL. (When applicable enter) ABBREVIATED FLIGHT CREW CHECKLISTS ARE AFFECTED BY THIS SUPPLEMENT. PEN AND INK WRITE-INS ARE AUTHORIZED TO ACCOMPLISH THE INSTRUCTIONS OF THIS SUPPLEMENT.
7. PURPOSE: THIS SUPPLEMENT IS ISSUED TO AMEND THE BASIC PUBLICATION.
8. INSTRUCTIONS:
 - A. PAGE (number). PARAGRAPH (number) IS (specific action, e.g., "amended to read", "deleted in its entirety", "amended to add the following paragraph", etc.)
 - B. PAGE (number). PARAGRAPH (number) IS (etc.)
9. THE FLIGHT MANUAL MANAGER FOR THIS PUBLICATION IS (name, office symbol, Commercial/DSN phone number, e-mail address).
10. STATUS PAGE:
 - A. CHECKLISTS AFFECTED (List all checklists affected by checklist number, date, and change numbers and dates)
 - B. SAFETY AND OPERATIONAL SUPPLEMENTS: (List all current and effective supplements by number, date and short title)

THE END

NOTE: If the IOS/ISS is released as an attachment to the transmitting e-mail or through a restricted access site, the "Subject" through "The End" must be included in the attachment. If the supplement contains graphics, the supplement and graphics must be attached to the transmitting e-mail, if e-mail is used.

H1102538

Figure 2-17. Format for FMP Publication Interim Safety/Operational Supplements

INTERIM OPERATIONAL SUPPLEMENT
TECHNICAL MANUAL
AVIATION UNIT AND INTERMEDIATE MAINTENANCE MANUAL
AIRFRAME TH-1H HELICOPTER

This publication supplements TO 1H-1(T)H-2-1, dated 1 August 2011, Change 4, dated 15 June 2013. Reference to this supplement will be made to the title page of the basic manual by personnel responsible for maintaining the manual in current status.

COMMANDERS ARE RESPONSIBLE FOR BRINGING THIS SUPPLEMENT TO THE ATTENTION OF ALL AFFECTED PERSONNEL

DISTRIBUTION STATEMENT D - Distribution authorized to the Department of Defense and U.S. DoD contractors only (Administrative or Operational Use), (1 August 2011). Other requests for this document shall be referred to AFLCMC/IIUBD, Robins AFB, GA 31098.

WARNING - This document contains technical data whose export is restricted by the Arms Export Control Act (Title 22, U.S.C., Sec 2751 *et seq.*) or the Export Administration Act of 1979, as amended (Title 50, U.S.C., App. 2401 *et seq.*). Violations of these export laws are subject to severe criminal penalties. Disseminate in accordance with provisions of DoD Directive 5230.25.

HANDLING AND DESTRUCTION NOTICE - Comply with distribution statement and destroy by any method that will prevent disclosure of the contents or reconstruction of the document.

Published under authority of the Secretary of the Air Force

17 July 2013

1. PURPOSE:

The purpose of this operational supplement is to provide changes to the basic publication as listed below.

2. INSTRUCTIONS:

a. Page 1-7, Amend the following:

Paragraph 1.2.3.a, Delete first two sentences of paragraph.

b. Page 1-9, amend the following:

Figure 1-2, Delete grease reference to rod end lubrication on mixing lever assembly under floor in illustration. See below.

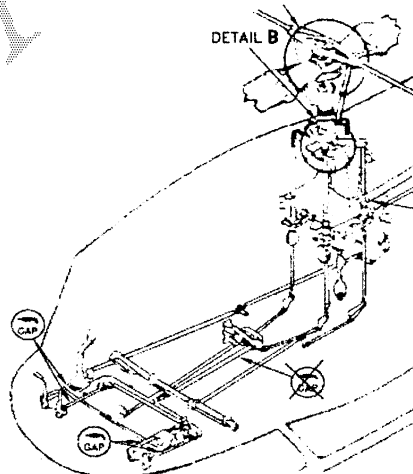

OPERATIONAL SUPPLEMENT

Figure 2-18. Additional Format Options for Interim Safety/Operational Supplements (Sheet 1 of 2)

CHAPTER 3

AIR FORCE STANDARD TECHNICAL ORDER MANAGEMENT SYSTEM

3.1 INTRODUCTION.

The Air Force Standard Technical Order Management System is used for the configuration management, storage, and distribution of TO management and content data. The scope of the Air Force Standard TO Management System includes activities from the creation and publication of TOs to their eventual decommissioning. The system includes hardware and software, personnel and facilities, and all manuals developed or acquired for organic operation, maintenance, inspection, modification, or management of centrally-acquired and managed Air Force military programs and end items. These TOs are developed IAW Technical Manual Specifications and Standards, non-embedded personal computer software which automates the function directed by a TO, contractor-developed manuals adopted for Air Force use, and approved Commercial Off-The-Shelf (COTS) manuals. The principal automated TO management applications is the ETIMS. These applications are employed to establish and manage information about Air Force TOs, disseminate current information on available TOs, manage TODO accounts for the ordering of TOs and the maintenance of TO records, and enable the viewing of eTOs online in the ETIMS connected mode and on eTools in the ETIMS disconnected mode.

3.2 ENHANCED TECHNICAL INFORMATION MANAGEMENT SYSTEM (ETIMS).

ETIMS is the AF System of Record, a secure web, GCSS-AF application accessible via the AF portal with the TO catalog, ordering and the TODO account management functions. ETIMS system functions to acquire, improve, publish, catalog, manage, stores, distributes and displays the official TOs needed for the safe and effective operation of AF weapon systems and equipment. ETIMS connects TO users and TO managers in the operational environment. ETIMS users are assigned “roles” that include a set of system privileges using a specific role to provide capability to perform various functions. ETIMS is the wholesale and retail user components of the AF Standard TO Management System. ETIMS interfaces with TODPS and SATODS. ETIMS also features an active eTO content repository, an eTO publisher/transformer, and an eTO viewer with online (connected) and portable (disconnected) modes. Primary users are TOMAs, TODO personnel, TO Distribution Account (TODA) personnel, TO Library Custodians, eTool administrators and TO users. To access ETIMS, prospective users must first obtain a Common Access Card (CAC) or an External Certificate Authority (ECA) with a minimum of a favorable National Agency Check and Inquiries (NACI) to establish access to the AF Portal. Once logged on to the AF Portal home page, ETIMS is accessed from the “Application A-Z Listing.”

NOTE

Procedures for contractors to obtain External Certificate Authority (ECA) certificates:	http://iase.disa.mil/pki/eca
DoD approved ECA certificates are issued from:	
VeriSign	https://www.symantec.com/verisign/shared-service-pki
ORC	(http://www.eca.orc.com/)
Identrust	http://www.identrust.com/certificates/eca/index.html .

3.2.1 TO Catalog. Provides information about all active, rescinded, and superseded TOs. The “Tech Order List”, “New TOs” and “New Increments” screens list TOs satisfying user-entered search criteria. Also, it provides TO Estimated Delivery Date (EDD), TO History, equipment cross-referencing and catalog notes. The ETIMS Catalog is updated in real-time with information for newly assigned TOs, TO increments (revisions, changes or supplements), TCTO Headers, TCTOs, Renumbered TOs and Reinstated/Reactivated TOs. This information is displayed by conducting an ETIMS “Tech Order List” and “New Increments” wildcard (*) search. Complete TO information (i.e., metadata) for all TOs is real-time in ETIMS and is displayed on the “TO Detail” screen. Information associated with all TO publication status changes is displayed in real-time. This includes information for TOs that were rescinded or reinstated, superseded/distributed and/or renumbered.

3.2.2 Accounts. Used to establish an ETIMS TODO account once prospective TODOs have an approved AFTO Form 43 that established the TODO Account code (Chapter 4). Other screens allow TODO, TODA and Library Custodians to manage

TO 00-5-1

assigned ETIMS accounts, sub-accounts and library accounts (ASL). ETIMS includes a centrally managed, Global TODO account (F*192X) which contains subscriptions to a number of commonly used, public releasable TOs for users without a local TODO (see paragraph 4.1.4).

3.2.3 Orders. Allows TODO to submit orders in ETIMS and the TODA to forward orders to the TODO for review.

3.2.4 Review. Allows TODO and TODA personnel to manage, maintain, review, and otherwise modify TO Series subscriptions. The Review Dates Screen provides a means to track when a review was accomplished for a particular month.

3.2.5 Reports. Allows TODO and TODA personnel to generate a variety of reports against subscribed TOs, TO increments and TCTOs in their ASLs.

3.2.6 My libs. Displays the aggregate set of Account(s), Sub-Account(s), and/or Library(s) (ASLs) to which the user has been given permission to use or manage.

3.2.7 My TOs. Displays the aggregate set of TOs for the “**My TOs**”, “**Library’s TO List**”, and “**eTool’s TO List**” screens.

3.2.8 My eTools. Allows eTool administrators to register and manage assigned eTools.

3.2.9 TO Viewer. Enables TO users to view properly formatted, numbered and indexed eTOs associated with the eTO library accounts to which they have access. The TO viewer supports both connected operations accessible via the AF portal and disconnected operation using eTools not connected to the AF portal.

3.2.10 Data Discrepancy Reports (DDR). Supports the reporting and viewing of TO catalog data discrepancies, TO print quality, distribution problems, etc. For issues of TO print quality and distribution, the package shipping label must be included for the issue to be resolved. Once the user has filed a DDR, the label can be e-mailed to the Air Force Technical Order Field Support Team (AFTOFST) at af.etimstofst@us.af.mil. Deficiencies in actual TO content are submitted as recommended changes (see Chapter 9).

3.2.11 ETIMS Training. The ETIMS functions described above are addressed in the ETIMS Software User Manual and the Field Users Guide. These resources are available on the AFTOFST home page at <https://cs3.eis.af.mil/sites/OO-LG-TO-HP/default.aspx>. Assistance with the ETIMS application is available with AFTOFST at DSN 872-9300, Comm. 850-882-9300 or af.etimstofst@us.af.mil.

3.3 TECHNICAL ORDER CATALOGS.

3.3.1 A CD-ROM version of the ETIMS TO catalog, numbered XX0-1-CD-1 and sanitized to delete non-releasable information, is published for FMS TODOs (see TO 00-5-19).

3.3.2 Information about NWC TOs, Explosive Ordnance Disposal (EOD) TOs or Country Standard TOs (for FMS use) is available in special indexes.

3.3.2.1 NWC TOs (Chapter 10) are indexed in TOs 0-1-11N and 0-1-11N-1-CD-1.

3.3.2.2 Nonnuclear EOD TOs (Chapter 10) are indexed in the Automated EOD Publication System (AEODPS) application within the Joint EOD Mobile Field Kit (JEOD MFK) software.

3.3.2.3 Country Standard TOs (TO 00-5-19) are indexed in the Security Assistance TO Data System (SATODS).

3.4 AIR FORCE TECHNICAL ORDER ARCHIVE.

The TO Archive which is the official record of copies regarding all published TOs has been decentralized and F*10SJ Account has been deleted. For emergency requests, please contact your respective TO Home Office at Warner-Robins, Hill, or Tinker. All Joint Nuclear Weapons Support technical orders are archived at Defense Threat Reduction Agency; to include 60N series. Submit requests for these TOs to AFNWC/ NDET, 2000 Wyoming Blvd SE, Kirtland AFB, NM 87117-5617.

CHAPTER 4

ESTABLISHING AND MANAGING TECHNICAL ORDER DISTRIBUTION OFFICES (TODO) AND ACCOUNTS (TODA)

4.1 INTRODUCTION.

4.1.1 The TO Distribution Office (TODO) POCs provide TO account administrative services for a unit or activity. The TODO POCs oversee organizational TO requirements and distribution operations. The TODO POCs establish and maintain a TO Account in ETIMS, establish and maintain organization TO Distribution Accounts (TODA) for organization sub-accounts and maintain records of TOs required and on hand in organization physical distribution media TO libraries.

4.1.2 This chapter provides procedures for the establishment and management of TODOs and TODAs, including the related ETIMS function. This chapter also provides for the designation of Lead TODO personnel for activities which will use ETIMS to view eTOs in disconnected mode. These topics are all addressed in the ETIMS Field Users Guide (paragraph 3.2.11). Procedures for establishing and managing physical distribution media TO/eTO library accounts are covered in Chapter 5. Additional procedures for establishing and managing TODOs for ordering and distribution of Nuclear Weapon Center, Nuclear Related Explosive Ordnance Disposal (EOD) and Nonnuclear EOD TOs are covered in Chapter 10. TODO and TODA training is covered in Chapter 11 and Appendix B and Appendix C, respectively.

4.1.3 TODO POCs are identified by their six digit, TODO Account code for the special TO requirements they manage. Foreign TODO POCs are assigned a TODO Account code beginning with the letters "D*" IAW TO 00-5-19 and are Security Assistance Program or "SAP" TODOs. Contractor Owned-Contractor Operated (COCO) TODOs with current Government contracts are assigned a TODO Account code beginning with the letters "E*" to signify they are a "Contractor" TODO authorized to order and directly receive TOs required to fulfill the requirements of a Government contract. All USAF, DOD, Federal government and Government-Owned, Contractor-Operated (GOCO) TODO POCs are assigned a TODO Account code beginning with the letters "F*" and are "Standard" TODOs. TODO POCs who manage Nuclear Weapons Center TOs are Nuclear Weapon TODOs. TODO POCs who manage Nuclear Related EOD TOs are Nuclear Related EOD TODOs. TODOs who manage nonnuclear EOD TOs are nonnuclear EOD TODOs.

4.1.4 ETIMS includes a centrally managed, Global TODO account which contains subscriptions to a number of commonly used, public releasable TOs for users without a local TODO. To request access to TOs in the Global TODO account F*192X, users should send an e-mail to todo3@us.af.mil which identifies their full name, AF portal ID and the TOs or TO Series to which access is required.

NOTE

The Global TODO account is only intended for TO users without a local TODO. Users associated with a local TODO should not request access to the Global TODO account. Global TODO account users who subsequently become associated with a local TODO account should unsubscribe to the Global TODO account.

4.1.5 TODO Outlook Mailboxes. Organizational mail boxes will be used to augment the ETIMS Home Screen notification process. All USAF F* accounts shall have an organizational email account and use of organizational accounts are recommended for other service/government accounts. Organizational mail boxes do not have to be capable of receiving encrypted email. TO managers must use the TODO's Outlook organizational mail box to send emails to Technical Order Distribution Office (TODO) personnel with access to the account box. To facilitate the process, USAF TODOs contact their base CS Workflow manager to process a request to establish an organizational TODO Outlook mail box. If an organizational email account already exists, TODOs will submit an AFTO 43 IAW steps outlined on the AFTO 43 instructions, to be added to the account and/or modify account fields to meet requirements listed below. For an individual to be authorized access to an organizational email account, STINFO policy rules apply. If an existing AFTO Form 43 does not have an organizational email account identified, a new AFTO Form 43 must be submitted so ETIMS can be updated accordingly. The TODO organization box must be created IAW TO 00-33D-2001-WA-1 with a suggested field format requirements: DISPLAY (example: AAC/AQY F* 18HQ TODO); ADDRESS (example: 102 West D Ave, Bldg 11, Suite 144); CITY (example: Eglin, AFB); STATE (example: FL); ZIP CODE (example: 32542-6808); DSN (example 872-9300); ALIAS (example: f18hq.todo); TITLE (example: ORG); BRANCH (example: USAF); MAJCOM (example: AFMC); ORGANIZATION (example: AAC); OFFICE (example: AQY); Business Phone Number (example: (850) 882-9300).

NOTE

Any email messages containing restricted-distribution data (codes B-F) must be sent to an email account capable of receiving email encrypted using a CAC or External Certification Authority (ECA) certificates.

4.1.6 **E-Mail Notification.** Organizational mail boxes will only be used to augment ETIMS notification of time-sensitive information and not for initial distribution of content changes. If the TO is available as -WA-1, TODOs will download any interim TO content updates using ETIMS. If the TO is not available in -WA-1 format, TODOs will follow instructions in ETIMS catalog notes on how to obtain TO content updates.

4.2 **ESTABLISHING TODOs.**

Organizations in need of Air Force TOs must establish TODOs (Figure 4-1) by processing an AFTO Form 43. The AFTO Form 43 can be downloaded at <http://www.e-publishing.af.mil/>

NOTE

- Before AFTO Form 43 can be completed, TODO must determine the type of account being created, ie, Standard TOs, Nuclear Weapons & Nuclear-Related EOD, Non-Nuclear EOD, or CPINS. This information will be found under the drop down menu in Block 2 of the AFTO Form 43. The account type will determine the e-mail address of the correct office to send the AFTO Form 43 (see e-mail address at bottom of mailing address). If the AFTO Form 43 is sent to the incorrect address, this will cause a delay in processing the form and creating the account.
- Before they can process an AFTO Form 43, TODO personnel require a CAC card or ECA certificate and Air Force Portal Access. Procedures for contractors to obtain an ECA certificate are found at: <http://iase.disa.mil/pki-pke/>. DoD approved ECA certificates are issued from VeriSign (<https://www.symantec.com/verisign/shared-service-pki/>) or ORC (<http://www.eca.orc.com/>) and Identrust (<http://www.identrust.com/certificates/index.html>). Air Force Portal access procedures are found at <https://my.af.mil>, including the need for, at a minimum, a favorable National Agency Check and Inquiries (NACI).
- Before they can process an AFTO Form 43, prospective TODO personnel should refer to paragraph 4.1.5 for organizational e-mail requirements. This TODO e-mail address will be entered onto the AFTO Form 43, will be associated with the TODO account in ETIMS and will be the alternate method of receiving interim TO e-mail messages. Any personnel in the TODO's unit may be affiliated with the organizational e-mail account that corresponds with the associated TODO account number assigned on the AFTO Form 43.

4.2.1 **Security Assistance Program (SAP) TODOs.** See TO 00-5-19 for information on Security Assistance Program (SAP) TODOs.

4.2.2 **COCO TODOs.** A Contractor Owned Contractor Operated TODO account that is established for direct support of the contractor mission, and has a commercial ship-to address and normally a .com computer network domain. The TOs required are dependent upon the performance and/or delivery of government contract tasks, and will lapse when the contract expires. TODO(s) must first obtain a CAC or an External Certificate of Authority (ECA) with a minimum of a favorable National Agency Check and Inquiries (NACI) to establish Air Force Portal access needed for ETIMS. The designated Contracting Officer representative must confirm an approved DD Form 2345; *Militarily Critical Technical Data Agreement* is on file prior to approving the AFTO Form 43. COCO TODOs must have all areas within Block 4d of the AFTO Form 43 completed to include contract number, cancellation date, government Contracting Officer's info and signature. Accounts with expired contract expiration dates will be inactivated for 180 days.

4.2.3 **GOCO TODOs.** A Government Owned-Contractor Operated (GOCO) TODO Account is established for direct support of a day-to-day government mission/activity. The TOs are required to support the government mission and are independent of the contract. The account is established and managed on government installation with a government shipping address and computer network with a ".mil" or ".gov" domain. These TODOs are considered government TODOs.

4.2.4 Standard TODOs. Because ETIMS access is required to establish and manage TODO accounts, prospective TODO POCs must first obtain a CAC or an External Certificate Authority (ECA) with a minimum of a favorable NACI and Air Force Portal access. The AF portal ID of the prospective, primary TODO is entered into Block 6 of the AFTO Form 43 to enable establishment of the ETIMS account. The primary TODO indicates they are a Lead TODO in Block 6 of the AFTO Form 43 if their activity will use ETIMS to view eTOs in disconnected mode. Once locally approved, the AFTO Form 43 is submitted to the address in Block 2, see Note in paragraph 4.2.

4.2.4.1 MAJCOM Account. MAJCOMs can assign an account for management of MAJCOM TOs and MAJCOM supplements to Global TOs within ETIMS catalog. If not already assigned, the MAJCOM CTOM representative is responsible for identifying account. MAJCOM CTOM representative will assign by submitting a helpdesk ticket to <https://www.my.af.mil/etims/ETIMS/ETIMS/util/HelpDesk.jsp>.

4.2.4.2 Base Account. Bases can have a single account, for each assigned MAJCOM, for management of Base TOs and Base supplements to Global TOs within ETIMS catalog. If not already assigned, units will submit a request through MAJCOM CTOM representative. MAJCOM CTOM representative will assign by submitting a helpdesk ticket to <https://www.my.af.mil/etims/ETIMS/ETIMS/util/HelpDesk.jsp>.

4.2.5 Nuclear Weapons and Nuclear Related EOD TODOs. The Using Command's Nuclear Weapon POC must approve the AFTO Form 43, IAW Chapter 10. Nuclear weapons and nuclear related EOD TODO codes are assigned and managed by AFNWC/ NDET. Use of ETIMS to maintain account records is mandatory (paragraph 10.5.2.2.2).

4.2.6 Nonnuclear EOD TODOs. The Using Command's Nonnuclear EOD POC must approve the AFTO Form 43, IAW Chapter 10. Nonnuclear EOD TODO codes are assigned and managed by AFCEC/CXE. Complete justification for needing nonnuclear EOD TOs will be entered in Block 10 of the AFTO Form 43. Nonnuclear EOD TODO accounts will not be established for contractors.

4.3 ACTIONS FOLLOWING TODO ESTABLISHMENT.

4.3.1 AFLCMC/LZPTP-Tinker SO Actions. AFLCMC/LZPTP-Tinker SO will establish a TODO Account for the primary and all alternate TODO's listed on the AFTO Form 43. This generates an automatic e-mail to the TODO's individual e-mail address notifying the TODO the ETIMS account is established and ready for use. AFLCMC/LZPTP-Tinker SO will maintain a copy of the approved AFTO Form 43 on file and return the approved form to the submitter.

4.3.2 CPIN Account Establishment. The AFTO Form 43 is a multi-purpose form used to establish both TODO Accounts and Automated Computer Program Identification Number System (ACPINS) accounts for the management of Computer Program Identification Number (CPIN) items. In Block 1 of the AFTO Form 43, TODOs must select required account type. If the organization will only manage software but not TOs, the AFTO Form 43 should be sent directly to ACPINS.USAFWorkflow@us.af.mil.

4.3.2.1 TODOs who manage classified software, that is available through electronic distribution, will maintain a waiver for removable media from SIPRnet. TODOs will initiate the waiver request for removable media through the installation information assurance office or manager.

4.3.3 TODO Actions.

4.3.3.1 Upon receipt of the approved AFTO Form 43, the primary TODO shall access and use the TODO Account code on the AFTO Form 43 to establish and manage their unit's TO/eTO requirements. The primary TODO must also enter the shipping address from Block 3 of the AFTO Form 43 in ETIMS. This is performed using the address button on the Office screen. For assistance in updating addresses in ETIMS, consult the procedural document at <https://cs3.eis.af.mil/sites/OO-LG-TO-HP/default.aspx>. If the TODO was designated a lead TODO on the AFTO Form 43, the TODO will know they have been assigned the eTool administrator role when the "eTool Admin" button on the ETIMS "TO Viewer" screen becomes active.

4.3.3.2 The primary TODO POC will maintain a file copy of the approved AFTO Form 43 for future reference and audit support.

4.4 TODO FUNCTIONS.

4.4.1 Group commanders or equivalent may designate a Lead TODO, normally at the Group level. In situations where the TO-Using Organization does not fall within a Group, Lead TODO functions may be supported by the organization's TODO or by agreement with another Lead TODO. Lead TODO personnel will perform all functions listed below:

4.4.1.1 Oversee TO Administrative services being provided by TODOs in the organization and advise the commander when the organization's TO/eTO requirements are not being satisfied. Address all TO system policy and procedure questions and issues or direct them to the focal point identified in the unit/MAJCOM supplement to this publication.

4.4.1.2 Assist organization TODOs with resolution of physical distribution media TO/eTO availability and distribution problems, including ETIMS TO ordering problems.

4.4.1.3 Assist activities to establish Nuclear Weapon, Nuclear Related EOD or Nonnuclear EOD TODOs when required to support special missions.

4.4.1.4 Assist organization personnel to establish a new TODO when required by mission changes or expanded TO/eTO library requirements.

4.4.1.5 Assist TODO personnel with completion of necessary forms to establish TODO accounts.

4.4.1.6 If applicable, and in coordination with the individual performing the Functional Systems Administrator (FSA) role, register and manage eTools for the distribution and viewing of eTOs in ETIMS disconnected mode. This includes registering the Master eTools, establishing eTool master and slave synchronization schedules, establishing libraries, associating eTools to libraries and associating users to libraries. Ensure all mission critical electronic TOs are available on eTools to support disconnected operations and to ensure continuity of operations in the event of network outages. Routinely audit eTO/eTool currency and resolve eTO/eTool distribution and synchronization problems. TODO should follow TO 31S5-4-ETOOOL-1 *ETOOOL Setup and Management*.

4.4.1.7 Whenever personnel change over occurs, ensure the new Lead TODO personnel are assigned eTool administration roles within ETIMS, if applicable.

4.4.2 All TODOs will:

4.4.2.1 Complete training IAW Chapter 11 and Appendix B and file or record completion of required courses to support future audits (paragraph 11.2.1).

4.4.2.2 Submit AFTO Form 43 to establish new, change POC or shipping address information or cancel TODO Accounts. If the shipping address changes, also update ETIMS with the address button on the Office screen. For assistance in updating addresses in ETIMS, consult the procedures available at <https://cs3.eis.af.mil/sites/OO-LG-TO-HP/default.aspx>. Maintain a file copy of the current AFTO Form 43.

4.4.2.3 Establish and maintain TO/eTO requirements and distribution records for the ETIMS ASLs which they manage.

4.4.2.3.1 ETIMS requirements records will be maintained on each TO-numbered CD-ROM/Digital Versatile Disk (DVD). When individual TO files are copied from the CD-ROM/DVD, the versions and digital file locations will also be indicated in the records. When revised CD/DVDs are received, these copied digital files must be updated.

4.4.2.4 Establish and service TODAs in organizational shops or offices where one or more TOs are required to accomplish assigned missions.

4.4.2.4.1 When the TODA is operated by a support contractor, document the assignment on an AFTO Form 43, signed by the Government Approving Authority (GAA) (Block 7) and the Contracting Officer (Block 8). File and maintain the form but do not submit it. Maintain confirmation from the contracting officer that the contractor has a valid DD Form 2345 on file.

4.4.2.4.2 Provide operational guidance to TODAs. Oversee TODA operations to ensure TOs on hand in the physical media TO library are current and in serviceable condition. Provide assistance as required by the TODA to obtain training and resolve TO/eTO access and distribution problems. Know their points of contact in the lead TODO office. Address all TO system policy and procedure questions and issues or direct them to the Command TODO.

4.4.2.5 For those TODAs whom the TODO has authorized to forward TO/ eTO orders in ETIMS, review, validate and send those orders. Ensure TODA POCs and TO Library managers include justification with orders for TOs requiring Sponsor

Approval (paragraph 6.1.2). For those TODAs not authorized to forward TO / eTO orders, send orders on their behalf. When an emergency requisition is needed, use the ETIMS “Emergency Justification Screen” (paragraph 6.3.1).

NOTE

Within ETIMS, sub-account POCs “forward” orders but only the account POC (i.e., the TODO) is authorized to “send” the order and generate TO shipments. Therefore, TODOs must exercise special care to ensure the order is valid before hitting the “Send Order” button in ETIMS.

4.4.2.6 Promptly cancel unneeded TO subscriptions using ETIMS. In line with the Air Force vision, accounts should be adding subscriptions for eTOs and zeroing out physical distributions, unless mission critical.

4.4.2.7 For ETIMS requisitions, take appropriate action to resolve TO distribution delays per paragraph 6.3.1. ETIMS users will regularly check the status of TO subscription and one-time requisition requests.

4.4.2.8 Document receipt of physical media TOs and TO increments in ETIMS and redistribute to sub-accounts within two duty days after receipt. Reproduce and redistribute Interim TO (ITO) and RACs (paragraph 2.16.3), and Immediate/Urgent TCTOs to affected sub-accounts by the fastest available means. Immediate/Emergency ITOs must be copied and forwarded within two (2) hours of receipt and urgent ITOs within 24 hours. Redistribute physical media TOs IAW TO dissemination procedures (paragraph 7.1). When formal TCTOs not applicable to the unit are received, document the receipt and save item to hard drive/server in case of future need or to show inspector/QA personnel IAW TO 00-5-15. This data can be exported into a file and presented to an inspector when requested if the formal TCTO is applicable but insufficient quantities are received, either one-time requisition the necessary copies or use local reproduction (see paragraph 7.6). If keeping paper copies, track not applicable TCTOs on separate spreadsheet as to why not applicable so that information can be readily available for a inspectors/QA personnel. TODOs will keep the applicability portion (typically first page) of the TCTO as verification that the TCTO is not applicable (referencing spreadsheet) and file along with the applicable TCTOs. If tracking not applicable TCTOs by ETIMS, the TODO has the option to input N/A TCTOs and the reason why they are N/A.

NOTE

In ETIMS, receipt physical media with the “Record Receipt” screens. Use of other screens to receipt TOs can result in the generation of unwanted, duplicate shipments. Use of the “Records Receipt” screens is documented in the ETIMS Field Users Guide accessible at <https://cs3.eis.af.mil/sites/OO-LG-TO-HP/default.aspx>.

4.4.2.8.1 e-TO TCTOs--Due to the lack of archive capability in ETIMS, it is recommended that all eTO media of TCTOs be uploaded into ETIMS and the applicable Archive at either Hill AFB, Robins AFB, or Tinker AFB, IAW TO 00-5-3.

4.4.2.9 Report packaging and shipping problems per paragraph 7.2.13.

4.4.2.10 Perform annual checks (paragraph 5.8.2). Support TODAs as required in performing weekly checks, if applicable.

4.4.2.11 Manage assigned physical distribution media TO / eTO library accounts (paragraph 4.6).

4.4.3 MAJCOM and Base TODO Accounts.

4.4.3.1 Account is responsible for creating MAJCOM/Base TOs and MAJCOM/Base supplements to Global TOs in support of TODOs within respective Command or Base.

4.4.3.2 When a MAJCOM TO or a MAJCOM Supplement to a Global TO is added to ETIMS catalog, only Accounts within the MAJCOM will be able to see information about the MAJCOM TO or Supplement. Accounts that do not belong to the specified MAJCOM will not be able to view TO or Supplement in ETIMS catalog.

4.4.3.3 When a Base TO or a Base Supplement to a Global TO is added to ETIMS catalog, only Accounts within the Base will be able to see information about the Base TO or Supplement. Accounts who do not belong to the specified Base will not be able to view TO or Supplement in catalog.

4.4.3.4 MAJCOM/Base TO and MAJCOM Supplement to Global TOs are indexed only and not available for on-line viewing through ETIMS. They can be uploaded to eTools for viewing with procedures found in eTool Field Users Guide (<https://cs3.eis.af.mil/sites/OO-LG-TO-HP/default.aspx>).

TO 00-5-1

4.4.3.5 MAJCOM supplements to MPTOs will still be indexed as Global TOs by AFTOFST in accordance with TO 00-5-3 and made available for on-line viewing through ETIMS.

4.4.4 Functional System Administrator (FSA) Responsibilities for eTools and Commercial Mobile Devices (CMDs).

4.4.4.1 MAJCOMs shall develop minimum FSA responsibilities for managing/maintaining eTools/CMDs in MAJCOM Supplements to this TO.

4.4.4.2 These devices will be controlled using standard tool/equipment accountability procedures resident in the maintenance environment.

4.5 TODA FUNCTIONS.

A TODO establishes a TODA for organizations where TOs must be readily available to support operation and maintenance mission activities. TODA personnel oversee physical distribution media TO/eTO requirements and distribution activities within the assigned mission area, shop or office. Organizations should normally assign at least two individuals to the TODA. TODA personnel should immediately inform the servicing TODO of changes in TODA personnel or changes in TO/eTO mission requirements. TODA personnel will:

NOTE

Contractors acting as TODAs or library custodians must have a current DD Form 2345 on file if any of the TOs managed are export controlled. If necessary, Parent Contractor Companies are authorized to hold a current DD Form 2345 for the contractor. See paragraph 4.2.2

4.5.1 Complete training IAW Chapter 11 and Appendix C and file any course completion certificates to support future audits (paragraph 11.2.1).

4.5.2 Establish and maintain the ETIMS sub-account assigned by the TODO required to support the unit mission (e.g., a unit may establish separate physical distribution media TO/eTO library accounts for fly-away mobility kits, aircraft files, specialist maintenance kits, etc.). If granted ETIMS account access by the TODO, TODA's may provide authorized, new users, access to the ETIMS eTO library account as required to support the unit mission. Notify the TODO promptly of any TODA personnel changes or when the TODA must be deactivated.

NOTE

Do not submit AFTO Forms 43 when creating sub-accounts in ETIMS.

4.5.3 Consolidate, validate and forward orders to the TODO.

NOTE

TODAs who fail to validate the accuracy of ETIMS orders may cause their TODOs to send duplicate orders and inadvertently generate wasteful unwanted TO shipments.

4.5.4 After recording receipt of a TO shipment in ETIMS, redistribute physical distribution media TOs and increments, and ensure TOs and TO updates are posted (Chapter 5).

NOTE

In ETIMS, receipt physical media with the "Record Receipt" screens. Use of other screens to receipt TOs can result in the generation of unwanted, duplicate shipments. Use of the "Records Receipt" screens is documented in the ETIMS Field Users Guide at <https://cs3.eis.af.mil/sites/OO-LG-TO-HP/default.aspx>.

4.5.5 Conduct weekly checks, if applicable (paragraph 5.8). Weekly checks may be delegated to the TO Library Custodian.

4.5.6 Manage assigned physical distribution media TO/eTO library accounts.

4.5.7 Address all TO system policy and procedure questions and issues or direct them to the TODO for resolution.

4.6 LIBRARY CUSTODIAN FUNCTIONS.

TO library custodians maintain physical media TO Libraries/eTOs/eTools consisting of one or more current TOs required for use on a continuing basis.

4.6.1 Authorized physical media TO libraries require posting of TO updates within the posting time limits (paragraph 5.6.6) to ensure filed TOs are complete and current. The eTools require a sync to their Master eTool IAW paragraph 5.6.7.2. Any user may post an update to a TO (Revision, Change or Supplement) and file it provided they are trained and authorized access to the data. Any user may do a manual “Tech Order Sync” on the eTool, to sync it to the Master eTool provided that the eTool is connected to the network. TO library custodians will:

- a. Notify TODO/TODA of all required addition, change, replacement or deletion of physical media TO/eTO requirements. Control and protect physical media TOs/eTOs stored on eTools. A cross-reference sheet will be used to show the location of physical media TOs filed or stored away from the physical media TO library (paragraph 5.5.2.1). Document missing TOs and conduct thorough searches (paragraph 5.5.1).
- b. Perform annual library inventories (paragraph 5.8).

4.6.2 TO Library custodians are designated and trained to manage physical media TO Libraries IAW Chapter 5. TO Library custodians will complete training IAW Chapter 11 and Appendix C and file any course completion certificates to support future audits (paragraph 11.2.2). Address all TO system policy and procedure questions and issues or direct them to the TODO/TODA for resolution.

4.7 MAJCOM AND BASE ETOOL GROUP ADMINISTRATOR FUNCTIONS.

4.7.1 Individuals assigned MAJCOM or BASE eTool Group Administrator can reassign eTools within respective MAJCOM/Base dependent on role assigned. They will also have access to metric reports which provide status of Master and Slaves, and PKI certificates used on Master eTools.

4.7.2 Assignment of MAJCOM eTool Group Administrator shall be limited to no more than three individuals per MAJCOM and assigned by helpdesk ticket submitted by MAJCOM CTOM representative.

4.7.3 Assignment of Base eTool Group Administrator shall be limited to no more than two individuals per base per MAJCOM and assigned by helpdesk ticket submitted by MAJCOM CTOM representative.

4.7.4 A list of individuals currently holding the position will be available on AFTOFST SharePoint site. Requests for assignment of MAJCOM and Base eTool Group Administrator roles shall be submitted to af.etimstfost@us.af.mil.

4.8 TODO, TODA AND LIBRARY CUSTODIAN CHECKLIST.

Table 4-1 is for guidance and reference. It may be used when establishing TODO accounts or sub-accounts and during inspections and surveillance visits. A partial check may be made using any group of items in the list. Discovery of major discrepancies warrants a detailed inspection of all functions. References are to this TO unless otherwise specified. The applicability column indicates whether the item applies to TODOs, TODAs or Library Custodian.

Table 4-1. TODO/TODA/Library Custodian Checklist

Description and Reference	TODO	TODA	Library Custodian
Does the Lead TODO oversee TO Administrative services being provided by other TODOs in the organization and advise the commander when the organization’s TO/eTO requirements are not being satisfied? (Paragraph 4.4.1.1)	X		
Does the Lead TODO address all TO system policy and procedure questions and issues or direct them to the focal point identified in the unit/MAJCOM supplement to this publication? (Paragraph 4.4.1.1)	X		

Table 4-1. TODO/TODA/Library Custodian Checklist - Continued

Description and Reference	TODO	TODA	Library Custodian
Does the Lead TODO assist organization TODOs with resolution of physical distribution media TO/eTO availability and distribution problems, including Enhanced Technical Information Management System (ETIMS) TO ordering problems? (Paragraph 4.4.1.2)	X		
If designated a Lead TODO on the AFTO 43, have eTool administrative privileges been assigned as evidenced by an active "eTool Admin" button on the eTool TO viewer screen? (Paragraph 4.3.3.1)	X		
Does the Lead TODO assist TODO personnel with completion of necessary forms to establish TODO accounts? (Paragraph 4.4.1.5)	X		
Do TODO personnel ensure the currency of eTOs on master eTools, if applicable? (Paragraph 4.4.1.6)	X		
Does the Lead TODO register and manage eTools for the distribution and viewing of eTOs in ETIMS disconnected mode and ensure continuity of operations in the event of network outages? (Paragraph 4.4.1.6)	X		
Does the Lead TODO ensure the AFTO 43, USAF Technical Order Distribution Office (TODO) Assignment or Change Request and corresponding ETIMS data fields are current? (Paragraph 4.4.2.2)	X		
Do TODO personnel ensure TO updates (revisions, changes or supplements) are received and re-distributed within allotted time, consistent with dissemination procedures? (Paragraph 4.4.2.8)	X		
Do TODO personnel ensure interim TOs (ITOs), RACs and immediate/urgent action TCTOs are reproduced and distributed by the fastest means consistent with dissemination procedures? (Paragraph 4.4.2.8)	X		
Do TODOs validate shipping address information every 90 days in ETIMS? (Paragraph 5.8.2.2.1)	X		
Do TODOs review and validate TODO account information annually using the most current AFTO Form 43 to ensure the name, e-mail address is correct? (Paragraph 5.8.2.2.2)	X		
Do TODO/TODA personnel ensure ETIMS requirements and distribution records to support the unit mission are established and maintained? (Paragraph 4.4.2.3 and 4.5.2)	X	X	
Do Organizational TODOs/TODAs annually verify TOs on subscription are still required and subscription quantities are correct in ETIMS? (Paragraph 5.8.2.1)	X	X	
Are all TOs posted within five work days for paper TOs from date distributed by the TODO? (Paragraph 5.6.6)	X	X	X
Are all Interim supplements posted in the affected TO within 36 hours if stored away from parent library or within five work days of receipt if filed in parent library? (Paragraph 5.6.6.1)	X	X	X
Are TOs issued to individuals (paragraph 5.2) posted prior to operating or maintaining equipment? (Paragraph 5.6.6.2)	X	X	X
Are all eTools connected to the local area network (LAN), wide area network (WAN) or ETIMS Master etool to receive updates at a period not to exceed 7 calendar days, UNLESS they are sent on a deployment as described per paragraph 5.6.7.1? (Paragraph 5.6.7.2)	X	X	X
Do TODA personnel and library custodians properly post revisions, changes and supplements? (Paragraph 5.6.8, 5.6.9, and 5.6.14)	X	X	X

Table 4-1. TODO/TODA/Library Custodian Checklist - Continued

Description and Reference	TODO	TODA	Library Custodian
Do the TODO/TODA personnel and library custodian files confirm completion of required training? (Paragraph 11.2.1, 11.2.2)	X	X	X
Do TODAs or TO Library custodians control access to TO libraries according to the most restrictive distribution limitations of the TOs contained therein? (Paragraph 5.3.2)		X	X
Has the TODA or TO library custodian established a charge out system? (Paragraph 5.5.1)		X	X
Is there a cross-reference sheet, such as the DD Form 2861, Cross-Reference, used to indicate the location of all TOs filed or stored away from the library? (This does not apply to ETIMS ETOV viewers). (Paragraph 5.5.2.1)		X	X
Do TODAs or TO Library Custodians perform and document annual library inventories to ensure the TOs are complete and current (current basic and all increments posted)? When there are too many TOs in a library to permit inventory during a single month, the TODA or Library Custodian may establish an incremental schedule to ensure a complete inventory of all TOs within the year. (Paragraph 5.8.2.3)		X	X
Do TODAs or TO Library Custodians perform a full LEP check of all paper TOs which have not had a full LEP check performed since the last annual library inventory during the annual library inventory check (paragraph 5.8.3)?		X	X

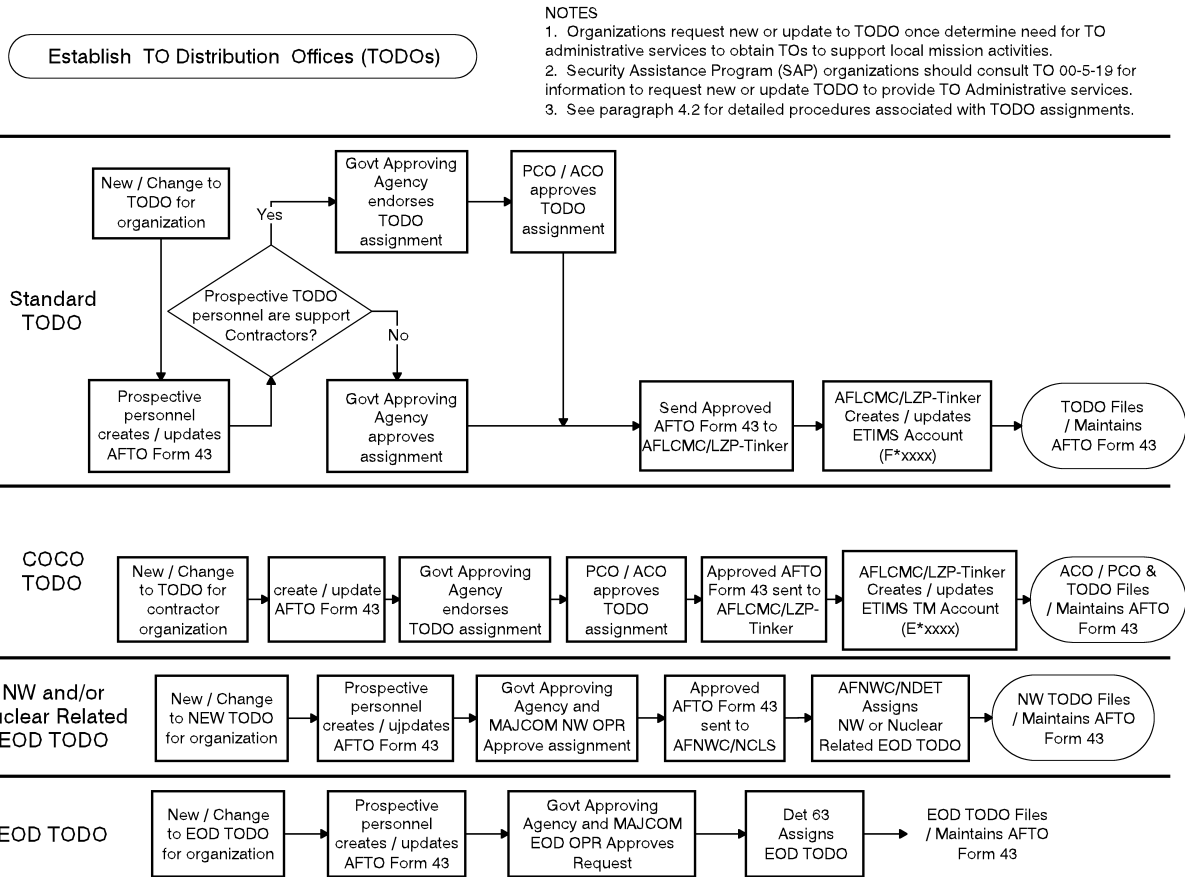

H0600145

Figure 4-1. Establish TO Distribution Offices (TODOs) Process

CHAPTER 5

ESTABLISHING AND MANAGING TECHNICAL ORDER LIBRARIES

5.1 PHYSICAL MEDIA TECHNICAL ORDER LIBRARIES.

Physical media TO Libraries consist of one or more current physical distribution media TO with all changes, revisions, and supplements (as applicable) maintained on a continuing basis. These libraries are established to provide users immediate access to the TOs required for the efficient and effective performance of assigned duties. TO libraries can be of many types and uses. All F* libraries that view mission critical eTOs through ETIMS “Connected Mode” shall establish and maintain eTools in accordance with TO 31S5-4-ETOOL-1 or ensure the library has a contingency plan to access those particular eTOs through an available eTool in the event ETIMS is not accessible.

5.1.1 Operational Libraries. These libraries are established and located to support O&M missions. Operational libraries will contain only those physical distribution media TO and eTO required to accomplish the O&M responsibilities of the owning activities.

5.1.1.1 TOs in dispatch kits (used to support off-site operations) are managed either as part of the unit library or as separate sub-account libraries.

5.1.1.2 Operational libraries may contain extra copies of TOs when required to support simultaneous O&M actions.

5.1.2 Aircraft Emergency Operating Instructions Libraries. These libraries may be established and maintained in the control tower, base operations, or the command post. If established, the library will contain the title page, List of Effective Pages (LEP), and the Emergency Procedures chapter of each -1 Flight Manual for primary assigned aircraft, and Safety Supplements or other supplements determined applicable thereto. The LEP will indicate which portions of these manuals are maintained in the library. A special notice is sometimes printed on the title page of a classified -1 Flight Manual, authorizing declassification of the Emergency Procedures chapter when it is withdrawn from the manual. In the absence of this notice, the chapter must retain the classification of the manual and be safeguarded; but radio transmission of instructions, in the clear, is authorized under emergency conditions.

NOTE

When classified emergency operating instructions have been transmitted in the clear, promptly report all available facts concerning the incident to the activity having technical responsibility for the manual. This activity will determine whether the information should be downgraded or declassified.

5.1.3 Aircraft Libraries.

5.1.3.1 Group commanders may direct retention of O&M TOs on board operational aircraft. Wing and Group commanders may specify other data to be carried in aircraft. Libraries will not be maintained in permanently grounded aircraft. TODOs and/or TODAs will assign separate sub-accounts to each aircraft library.

5.1.3.2 Provisions of North Atlantic Treaty Organization Standardization Agreements (NATO STANAGs) 3462 and 3767, Central Treaty Organization (CENTO) STANAGs 3462 and 3767, and Air Standardization Coordinating Committee (ASCC) AIR STD 44/16D require that applicable -1, -5, and -9 TOs, and the Aircraft Weight and Balance Handbook, shall be carried on cargo-type aircraft to facilitate loading operations during international combined operations involving NATO, CENTO, or ASCC nations. Changes or deviations from this requirement will not be made without the authorization required by AFI 60-101, Operations and Resources. The U.S. will limit the carrying of cross-servicing information to transport and bomber aircraft in accordance with AIR STD 11/16A.

5.1.3.3 Technical data required by other Air Force directives will be maintained as prescribed for each aircraft.

5.1.3.4 Current, serviceable technical publications must accompany transferred aircraft. **EXCEPTION:** Libraries will be removed from aircraft sent for Programmed Depot Maintenance (PDM), and will be kept current by the TODO/TODA at the home station. Libraries remaining on board an aircraft arriving at a depot will be crated and shipped back to the home station at their expense.

5.1.3.5 Aircraft commanders may include additional publications as required.

TO 00-5-1

5.1.4 Transient Aircraft Library. This library may be established on bases where it is common to service or perform organizational or intermediate level maintenance on transient aircraft not normally assigned to the base. The library will usually contain Category 1 aircraft TOs for each type or model of aircraft that would normally be expected to use the maintenance or service facilities of the base.

5.1.5 Reference Libraries. These libraries are authorized for use by activities whose duties do not include operating or maintaining equipment. TOs in reference libraries need not be current and will be marked "FOR REFERENCE USE ONLY". Account records for reference libraries will be maintained.

NOTE

Libraries used for support of O&M users, for example those at MAJCOM headquarters, Product Improvement, Quality Assurance, and TO management activities, are considered operational libraries and must be current.

5.1.6 Training Libraries. These libraries are established to support training courses.

5.1.6.1 TOs used for training must be current, and may be loaned to students solely for use in the classroom. TOs will not be given to students as handouts, although portions of TOs may be reproduced for student retention, if required. Reproduced TO portions will either be returned upon training completion or destroyed. TOs in training libraries will be marked "FOR TRAINING USE ONLY".

5.1.6.2 Filing methods to facilitate issue of publications for training operations may be devised locally (paragraph 5.6.6.6).

5.1.6.3 The TO Pub Date in the TO Catalog will not be the sole criteria for determining currency of training TOs. The compatibility of the TO with the training equipment item, the criterion or enabling objective, the technique employed (as identified in the plan of instruction or other applicable course control documents), and TO changes that affect curriculum are factors that must be considered. TO material used to train on operational aircraft or equipment must be current. TOs used in non-equipment oriented instructions must be pertinent to the training exercise identified in the course control documents.

5.1.7 Contractor Libraries. TODOs may control the distribution of TOs to eligible contractor recipients IAW DoDM 5200.01 Vol 1-4/AFI 16-1404, *Air Force Information Security Program*, AFI 61-201, and for reasons specified in this TO. For Air Force TO System implementation of the STINFO Process, TODOs are considered "Controlling DoD Offices (CDO)" and may make primary distribution to any accounts and sub-accounts based on mission requirements. If Proprietary TOs must be distributed to GOCO Accounts, the contractor personnel must have signed non-disclosure agreements on file with their company.

5.1.8 Rescinded Copies Libraries. Air Force activities may retain rescinded TOs when needed for maintaining training equipment, special programs and projects. Immediately upon notice of TO rescission ("Search New, Updated Inactive TOs" part of the TO Catalog), the copy to be retained will be placed in a rescinded copies library separate from active TOs; and the binder and TO title page will be conspicuously marked "RESCINDED". If an Air Force activity must obtain a previously rescinded TO, it may be requisitioned from the appropriate PM or SCM according to paragraph 6.2.

5.1.9 Reclamation Removal Work Package Library. These packages are authorized only for the Aerospace Maintenance and Regeneration Center (AMARC). Technical data extracts used for locating parts and equipment in AMARC aircraft will be marked "FOR REFERENCE ONLY". Technical data extracts used for maintenance must be marked to show the date and version of the parent document (unless the document title page showing this data is part of the extract). These maintenance extracts do not require the reproduction date or FOR REFERENCE ONLY markings. The extracts must be maintained in MDS-specific Reclamation Removal Work Packages. TOs and extracts included in Reclamation Work Packages may not be the most current editions according to the TO Catalog, but will be the latest versions applicable to the MDS covered.

5.1.10 Work Package Libraries. Selected depot and intermediate maintenance manuals contain Work Packages (WPs) for specific tasks. Maintenance organizations are authorized to establish optional individual work package libraries. This includes reproducing and distributing work packages internally to designated workstations. The using maintenance organization will ensure that individual work packages are current and complete.

5.2 TECHNICAL ORDERS ASSIGNED TO INDIVIDUALS.

Job-related TOs are authorized for assignment to individuals such as missile crew members, crew chiefs, system specialists, supervisors, research and development personnel, training instructors, and others having justified requirements for personal

use copies. Library custodians must keep accurate records of individually assigned TO copies. TOs assigned to individuals are not the property of the individual, but belong to the parent library. The individual will post updates upon receipt to maintain the copies in current status; the TOs are subject to inspection. Upon transfer or separation, the individual is required to return the copies to the appropriate library. Personal copies of Flight Manual Program (AFI 11-215) publications are given to pilots and flight crew members on active flying status.

5.3 TECHNICAL ORDER ACCESS CONTROL.

5.3.1 General. Release, distribution and access to physical distribution media TOs and eTOs and other technical data is controlled to prevent unauthorized disclosure.

5.3.2 Physical Distribution Media TOs. TODAs or TO library custodians will control access to physical media TO libraries according to the most restrictive distribution limitations of the TOs contained therein (paragraph 7.1).

5.3.3 ETIMS eTOs. TODO and TODA personnel will provide user access according to the most restrictive distribution limitations of the eTOs contained therein (paragraph 7.1).

5.3.4 Digital TO Files (other than ETIMS eTOs). TO using organizations electing to host digital TO files on local servers must develop and document procedures for limiting access IAW AFI 33-115, *Air Force Information Technology (IT) Service Management*.

5.4 CONTRACTOR ACCESS TO USAF TECHNICAL ORDER LIBRARIES.

Contractors may require access to USAF TO libraries when performing contract duties on government installations. The contractors must be identified by the Contracting Officer or Requirements Generator in a GAA letter to the library custodian. When access is required, the following procedures must be followed.

5.4.1 Contractors must submit a contract related TO library access request, including a list of specific TOs to be accessed, through the GAA (See Appendix A for GAA OPR definition). The GAA will provide a letter to the TO Librarian approving access of designated contractor personnel and identifying TOs approved for contractor use by system/program technical content managers. Data authorized for use (including B or E distribution limitation and limited rights or proprietary) will be addressed in the GAA letter. Upon change to contract terms, contract personnel and/or tech data authorized for access, or change in assignment as GAA, notifications will be provided to the applicable library personnel. If access to export-controlled or classified TOs is required, the GAA will also verify the contractor security clearance, possession of a valid DD Form 2345, and require contractor personnel using a library containing export-controlled TOs to read and sign a copy of the "Notice to Accompany the Dissemination of Export-Controlled Technical Data".

5.4.2 A copy of the access approval and authorized TO list will be maintained by the library custodian. TOs will not be removed from the work area served by the library by contractor personnel. The GAA is responsible for notifying the TO Librarian of any changes in access requirements or termination of the contract requiring access.

5.4.3 Access to limited rights or proprietary data in TOs is strictly forbidden without the express approval of the holder of the rights. When access to TOs with distribution statements "B" or "E" is required, specific permission of the controlling Air Force office is required (Appendix E).

5.4.4 Access to TOs in the library will be limited to those required for contractual purposes and listed on the access approval list. The specific contract language will stipulate what access controls apply to a particular contract location based on current STINFO directives. Contractors can order TOs according to paragraph 7.1.

5.4.5 The TO library custodian is responsible for controlling contractor access to TOs other than those approved in the access approval letter.

5.4.6 Contractor ID badges must be worn on an outer garment at all times while contractor personnel are in the library.

5.4.7 Advisory and Assistance Services (A&AS) contractors performing direct support of Air Force or other government activities shall be so identified in writing by the GAA, including any authorization for access to classified and restricted distribution TOs, if required. These contractor personnel will be provided the same access and privileges as government personnel for the duration of the A&AS contract.

5.5 FILING PHYSICAL DISTRIBUTION TOS AND USE OF BINDERS.

NOTE

This section applies strictly to TOs on physical media.

5.5.1 General. The method of filing must facilitate locating and maintaining physical distribution TOs. Activities maintaining a physical distribution TO library will use a charge-out system to account for TOs removed from the library area. Missing TOs will be documented and thorough searches conducted. Physical distribution TOs are normally filed in TO index or alphanumeric sequence. TOs will be filed in any type of binder which will protect and facilitate the use of the TO. Some Flight Manual Checklists may not require a protective binder, in the event they are printed on “never-tear” paper or like products. If so, they are excluded from this requirement. TOs requiring nonstandard size binders and digital media may be filed separately within the library. Classified TOs will be filed in accordance with DoDM 5200.01 Vol 1-4 and AFI 16-1404 *Air Force Information Security Program*.

5.5.2 Labels and Markings. Binders will be labeled to indicate contents. The AFTO Form 32, *Technical Order Binder Label*, may be used and is available on the AF e-Publishing web site at <http://www.e-publishing.af.mil/>. Optional information, such as office symbol or type of equipment covered, may be added to the labels. For TOs which may be filed or stored away from the library, the label should contain information on accountability (for example, kit number, account to which assigned, or assigned local control numbers). Digital media will be marked with file identification and copy numbers using permanent felt-tip markers, either on the disk or on the protective sleeve. **DO NOT MARK ON THE UNPRINTED SURFACE OF A CD-ROM/DVD.**

NOTE

Schematics and wiring diagrams may be laminated with a protective plastic covering, appropriately cross-referenced from the TO, and kept in a designated location when not in use.

5.5.2.1 A cross-reference sheet, such as the DD Form 2861, *Cross-Reference*, will be used to indicate the location of all physical distribution media TOs filed or stored away from the library, e.g. TOs stored on aircraft, in tool kits, or in satellite libraries controlled by the same TODA or library custodian. This does not apply to eTOs accessed through ETIMS ETOV viewers.

5.5.2.2 In the event a TO number is omitted from the ETIMS catalog (sometimes called AF TO catalog) in error, do not remove the TO from the library unless the TO is first listed as rescinded or superseded in the ETIMS catalog, or the TODO declares it excess to the needs of the organization. If you are unable to find the TO number and believe an error has been made, contact the AFTOFST (af.etimstofst@us.af.mil).

5.5.2.3 TODAs or library custodians will prominently mark the title pages of “incomplete” and “superseded” TOs. Superseded TOs may be retained in the library at the discretion of the unit commander, pending receipt, documentation, and filing of superseding TOs.

5.5.3 TO Sets. When TOs are used together as a set the MAJCOM or unit may allow filing the sets in set binders numbered as “SET (X) of (Y).”

5.5.4 Unit Filing Methods. Each unit is authorized to devise a method for filing non-8 1/2 x 11-sized Inspection Workcards, Code Manuals, TO Checklists, and 33K Series TOs. If, for ease of use, workcards are split and distributed among activities within a unit, cross-reference sheets must be used to show the locations.

5.5.5 Renumbered TOs. When a TO is renumbered, the TO Manager issues a change with both the new and old TO numbers on the title page, and only the new number shown on any other changed pages. Unchanged pages will reflect the old TO number until the next TO revision. File the TO in the new correct sequence.

5.5.6 Commercial Publications. Commercial publications with TO numbers assigned may be filed with other TOs or in a separate location with a cross-reference sheet in the library. Identifying Technical Publication Sheets (ITPS – paragraph 2.17.5) will remain with the publications. Base local purchase commercial publications will not be filed in TO libraries.

5.5.7 Preliminary TOs (PTOs). PTOs will be filed in sequence with formal TOs.

5.5.8 Preliminary COTS Manuals (paragraph 2.9). File this data and subscribe to the formal TO.

5.5.9 Digital TOs. For digital TOs distributed on a physical medium (for example, CD-ROM, DVD), the medium will be filed using the same sequence logic as the unit paper TOs.

NOTE

- Classified TOs must not be transmitted over a non-EMSEC (EManation SECurity) protected LAN/WAN, or used on a non-EMSEC computer, and classified disks/hard drives must be protected according to DoDM 5200.01 Vol 1-4.
- TO files on CDs can be downloaded onto a file server accessed through a LAN, or downloaded from a CD drive on the LAN onto the computer hard drive or a floppy disk, or used directly from a CD tower connected to the LAN. In these cases, one copy of the CD can replace multiple paper copies. Where the LAN is unavailable or hard drive space is limited, CDs may be ordered for each account and be used directly with individual computers having a CD drive.

5.5.10 Interfiling Prohibition. Local workcards, checklists and job guides should not be interfiled in TO binders with the related TO.

5.5.11 Local Page Supplement Front Matter. The front matter of local page supplements is filed prior to the TO title page. (See Figure 5-1.)

5.5.12 Other DoD Component Technical Manuals. DoD TMs without Air Force TO numbers will be filed alpha-numerically by TM number and maintained the same as Air Force TOs.

5.5.13 Non-TO Documents. Non-TO documents such as unnumbered commercial manuals and other authorized technical references will not be filed in the TO library but shall be managed and filed IAW unit procedures.

5.6 POSTING TECHNICAL ORDER UPDATES

“Posting” is the process of incorporating updates into the organization’s on-hand TOs, and is critical to ensure that TOs are maintained current and accurate for use.

5.6.1 Authorized Updates. Only update types listed in this TO are authorized for use. Questions about receipt of any other technical documents should be referred to the appropriate TO Manager. Interim Changes (ICs - AFI 33-360) are not authorized. Interim Changes are authorized for JNWPS TOs (see paragraph 10.3.2).

5.6.2 Supersedure Notices. Check the supersedure notice on the title page of the TO update to ensure that only those supplements and changes actually being superseded are removed/destroyed. If the supersedure notice states that only part of a TO is superseded, that part will be removed. If it cannot be removed, it will be marked out and a notation will be made on the title page reflecting the TO update that superseded the marked portion.

5.6.3 Foldout Pages. Foldout pages are collated at the back of a basic, revision, or change for distribution. The pages will be posted to the TO in the sequence listed in the LEP .

5.6.4 Formal and Interim TO Supplements. Printed formal and ITO supplements will be posted in inverse numerical sequence (highest number on top) in front of paper TO title pages.

TO 00-5-1

5.6.5 LEP Checks. Requirements for performing LEP checks during TO posting are in paragraph 5.8.3.

NOTE

New TO increments for ICBM maintenance TOs will, IAW AFI 21-200, *Munitions and Missile Maintenance Management*, require a QA review after the TODO has received and redistributed the increment. This QA review (5 days maximum) is done prior to a library custodian receiving the increment and is not considered part of the posting time limits.

5.6.6 Posting Time Limits. All TOs will be posted on or after the publication (effective) date is reached and must be done within five work days for paper TOs from date distributed by the TODO except for the following:

5.6.6.1 Interim supplements will be posted in the affected TO within 36 hours if stored away from the parent library or within five work days of receipt if filed in the parent library.

5.6.6.2 TOs issued to individuals (paragraph 5.2) will be posted prior to operating or maintaining equipment.

5.6.6.3 Computer program operator manuals received prior to receipt of related computer programs will be held for filing until receipt of applicable media. Superseded manuals and related programs will be used until both the new programs and companion manuals are received and verified.

5.6.6.4 Air Force Reserve Command (AFRC) units which are fully staffed only two days a month will post routine TOs, changes and revisions during those two days. This exception does not apply to Maintenance or Operations Groups. Annual checks may also be performed during these two days. Interim TO safety and operational supplements and immediate and urgent action TCTOs will be posted by permanent party personnel within five work days after receipt.

5.6.6.5 Routine updates to TOs maintained at unattended Communication-Electronic (C-E) sites will be posted prior to use of the affected TOs.

5.6.6.6 TO updates for TOs to support training courses do not need to be posted when courses are not being held; however, before the courses are offered again, the TOs must be updated and maintained current during the course.

5.6.6.7 When time permits, home stations will forward TO updates to Training Detachment (TD) instructor personnel on extended TDY, who will post TOs within five work days of receipt. Otherwise, the instructors will post TOs within five work days after return to home station.

5.6.6.8 TODOs will distribute TOs and updates with future effective dates upon receipt like any other TOs; however, existing TOs in the active library will not be updated or replaced until the effective date.

5.6.6.9 When TO updates will affect both the parent TO and associated checklists, the TODO will not distribute any of the updates until all are received.

5.6.6.10 The time limit for posting newly-received TO updates will not start until all earlier increments have been received (paragraph 5.6.9.2 and paragraph 5.6.9.3).

5.6.7 Updating e-Tools.

5.6.7.1 TOs/eTOs/eTool on deployments less than 60 calendar days will be updated within five working days of return to home station. For deployments exceeding this period, TO/eTO/eTool updates will be forwarded and posted at least every 60 calendar days until they are returned home-station to resume normal posting/syncing operations within five working days upon return. For deployments longer than 6 months, see paragraph 7.2.9. Note: RACs and safety supplements will be distributed/posted to deployed TOs/eTOs/eTool per paragraph 4.4.2.8, regardless of the length of the deployment.

5.6.7.2 All eTools will be connected to the Local Area Network (LAN), Wide Area Network (WAN) or ETIMS Master eTool to receive updates at a period not to exceed 7 calendar days.

NOTE

- The ETIMS catalog and repository is updated immediately upon TO Manager marking increments Available for Index. All on-line eTO library accounts will be presented with any updated eTOs at that time. ETIMS Master eTools will be presented with any updated eTOs at the next synchronization, and, in-turn, all associated slave eTools.
- If AF Portal connectivity problems prevent the updating of ETIMS eTOs on a master eTool, any eTO updated within 7 calendar days of the loss of connectivity will be considered current, as well as its synchronized slaves. Once AF portal connectivity is restored, ETIMS eTO updates must be loaded onto the master eTool and slaves within 7 calendar days.
- To preclude the possibility of IPADS being considered out of date, it is recommended not scheduling all to be updated on same day.

5.6.8 Posting Revisions. The title page, including the supersedure notice will be checked against the title page of the superseded TO. If no discrepancy exists, the replaced TO will be removed and the revision filed in its place. When checked data is not in agreement, the discrepancy must be resolved; contact the appropriate TO Manager if necessary. Posting will be completed if possible, and discrepancies will be annotated on the LEP.

NOTE

- Commercial manuals may not have an LEP. When posting revisions to such page based manuals, first identify any missing pages, if possible. Annotate the missing page numbers on the title page, along with the posting date and the poster's initials. Once the missing pages are obtained and posted, amend the annotation on the commercial manual title page.
- Brief manuals do not have a LEP and are only revised, not changed. When posting the brief manual revision, identify any missing pages. Annotate the missing page numbers on the abbreviated title page, along with the posting date and the poster's initials. Once the missing pages are obtained and posted, amend the annotation on the brief manual title page.
- Flight manuals are authorized per AFI 11-215 to remove specific portions of the TO that do not apply to the unit MDS weapons systems or equipment, the LEP will be documented to show that the portions were not applicable and removed.

5.6.9 Posting TO Changes.

5.6.9.1 The basic date on the title page of the change will be checked against the basic date of the title page to be replaced. Annotations will be transferred from the old to the new TO title page, as required. The changed and added pages will be inserted into the TO. The replaced and deleted pages will be removed and destroyed according to the Disposition or Handling and Destruction Notice (paragraph 7.1.4).

5.6.9.2 Changes received before the basic TO affected will be held (not posted) until receipt of the TO. ETIMS records will be checked to ensure subscription requirements for missing TOs have been established and that missing TOs have been requisitioned.

5.6.9.3 If an earlier change is missing, the later change on hand will be held for receipt of the missing change. The TO title page will be annotated to reflect the missing change. ETIMS records will be checked to ensure subscription requirements for missing TO changes or complete basic TOs have been established and missing changes or basic TOs have been requisitioned. When the missing change is received, all changes will be posted.

5.6.9.4 For the following issues, contact the TO Manager:

5.6.9.4.1 When a page is indicated on the LEP as a changed page, but the change number has been omitted from the listed change page;

5.6.9.4.2 When a changed page is received that is not listed as such on the LEP, write the correct page listing in the proper place on the LEP;

TO 00-5-1

5.6.9.4.3 When the LEP reflects a changed or added page that is not included in the change package, annotate the LEP and the page which was supposed to be replaced, or added, to say "Page 4-1 not received with change.":

5.6.9.4.4 When a change is received with a publication date later than the date reflected on the LEP, the LEP will be corrected;

5.6.9.4.5 If the basic date on a changed title page does not agree with the basic date of the TO in the library, the ETIMS Catalog will be checked to determine the correct basic date and appropriate action will be taken to obtain the correct TO or report/correct the discrepancy.

5.6.9.4.6 Changes to some new TOs may contain a Change Record page to provide a permanent change record. The change record page will be posted as the first right-hand page following the LEP.

5.6.10 Appendixes. Appendixes are continuations of basic TOs and are posted in alphanumeric sequence following the basic TO or the preceding appendix.

5.6.11 Supplements to Other Services TMs. When an Air Force TO supplement revises information in another services' TM adopted for Air Force use, the information is applicable only to the Air Force. Updates to other services' TMs are generated in the same style and format as the basic manual.

5.6.12 Changes to Other Services' Publications. Changes to non-joint TMs issued by other services will be posted in accordance with those services' procedures (see DA Pamphlet 25-40 Appendix E, NAVAIR 00-25-100 WP 012 00, and MCO P5215.17C Chapter 4).

5.6.12.1 Department Of The Army (DA) Publication Changes. Changes to unbound (loose-leaf) DA publications are normally issued on a replacement page basis, and are handled like Air Force TO changes. Changes to DA bound publications will be posted intact in numerical sequence following the basic publication.

5.6.13 Posting RACs.

5.6.13.1 For users of paper TOs, RAC files will be printed and/or copied double-sided for posting like any other TO change. For digital TO users, the merged digital file will be used in place of the previous digital version. LEP checks are not required for the merged digital file.

5.6.13.2 TODO/TODA account records for the affected TO must be updated in ETIMS to document receipt of the RAC for all using accounts.

5.6.14 Posting Supplements.

NOTE

ISSs and IOSs remain in effect until specifically incorporated, superseded or rescinded, no matter how long the period.

5.6.14.1 Post supplements IAW Figure 5-1. When a single block of sequential numbers has been used to number both Safety and Operational supplements (formal or interim), the supplements will not be separated by type; if there are separate numbering sequences, safety supplements will be posted in front of operational supplements. Each FMP supplement status page will remain with the parent supplement.

5.6.14.2 If a supplement affects a specifically numbered change (or changes), but the change(s) has not been received, the supplement will be held for receipt of the missing change. The TO title page will be annotated to reflect receipt of the supplement and non-receipt of the numbered change. ETIMS records will be checked to ensure subscription requirements for missing TO changes have been established and missing changes have been requisitioned. When the missing change is received, it will be posted along with the supplement and the title page annotations deleted.

5.6.14.3 If Work Packages/Work Cards are filed separately from the basic TOs, a copy of applicable safety and operational supplements must be posted with each Work Package/Work Card breakout.

5.6.14.4 Temporary pages to checklists and workcards received with a supplement to the TO or Flight Manual will be posted in accordance with the instructions provided in the supplement. Receipt of these temporary pages will not be recorded in ETIMS. The LEP will be annotated to indicate which pages, if any, have been replaced. Replacement pages need not be

posted if the supplement states that it is temporary and will not be incorporated into a later revision or change (this applies to paper TOs only) .

5.6.14.5 If TO users determine that a TO has become a problem due to the number and character of supplements, the organization Product Improvement Manager (PIM) should notify appropriate Equipment Specialist for the weapon system TO. The parent MAJCOM, if not Lead Command for the Weapon System, will request the Lead Command to notify the PM or SCM. The PM/SCM will direct a TO review by the assigned TO Manager, TCM, and user representatives to verify the problem and determine the most effective remedy (change or revision).

NOTE

TOPS are not an authorized method of supplementing TOs indexed in ETIMS.

5.6.15 Posting TOPS. The TOPS title page will be filed in front of, and facing the same direction as, the existing TO title page. The title pages of active TOPS are posted in reverse numerical sequence in front of the basic title page (cumulative TOPS title pages supersede previously issued title pages). TOPS pages will not be removed from active TOs unless the TOPS is listed in the supersedure notice on the title page of a TO change, TOPS, supplement, or revision; or the specific TOPS number appears as deleted or replaced in the AF TO Catalog or latest TOPS title page.

5.6.15.1 The TOPS data pages will be posted facing the affected TO page.

5.6.15.2 When pages from more than one TOPS affect the same TO page, post the most recent TOPS page directly facing the affected TO page (TP-3 on top of TP-2, etc.).

5.6.15.3 When the data supplementing an individual page cannot be accommodated on a single TOPS page, the TOPS continuation pages will be posted opposite the supplemented page in ascending sequence. For example, when supplementing page 6-10, TOPS page 6-10 will be posted facing page 6-10. TOPS continuation page 6-10.1 will be posted behind TOPS page 6-10, etc. When a TOPS continuation data page is superseded by another TOPS continuation data page with the same page number, the new page will be posted in page number sequence instead of TOPS number sequence.

5.6.15.4 When a change to the TO supersedes TOPS pages that are part of a cumulative TOPS, line out the superseded TOPS and associated data pages and annotate the supersedure on the TOPS LEP. Remove superseded data pages.

5.6.16 Annotating Supplements (Paper Copies Only).

5.6.16.1 Annotate references to posted supplements on the TO title page. Annotate the reference to TCTO supplements on the first page of the basic TCTO. Annotate the reference to a supplement affecting an individual maintenance work package on the title page of the basic TO. When the work package is separated from the basic TO, also annotate the reference on the work package title page.

5.6.16.2 If a supplement is missing, annotate the TO title page to reflect the missing supplement.

5.6.16.3 To indicate that a particular paragraph is supplemented, circle the paragraph number and write the supplement number next to the paragraph in pencil. Use alternate procedures such as arrows or circles to indicate modified items not in paragraph form.

5.6.16.4 Do not obliterate deleted or replaced paragraphs from the TO unless specifically directed to do so by the supplement.

5.6.16.5 Each flight manual and flight manual supplement contains a status page that lists all outstanding supplements as of the publication date. Annotating supplemented items in flight manuals is mandatory in accordance with AFI 11-215.

5.6.16.6 Annotating the TO paragraphs or sentences affected by a TOPS is a MAJCOM option.

5.6.17 Posting ITPS. ITPS cover page shall be posted immediately on top of the COTS manual title page. The ITPS cover page shall be posted immediately on top of the COTS manual title page. If included, the Safety Summary will be posted immediately below the ITPS cover page. When included, the CMS pages, consisting of the title page, supplemental information, and if used, the LEP, shall be posted immediately behind the COTS manual. Only the CMS pages shall be assigned a routine supplement letter. The supplement letter will be incremented to the next when updates to the CMS pages are issued. The supersedes statements on both the ITPS cover page and CMS title page will reflect the current update.

TO 00-5-1

5.6.18 Posting Priority Updates for TOs on CD-ROMs. TODOs will be notified by ETIMS when a TO distributed on CD-ROM must be updated before the next update cycle. The notification will provide instructions on accessing and uploading the updated TO file. The TODO will upload the revised file to a local server or provide copies to individual users for uploading on PC hard drives.

5.6.19 Posting TCTOs. TCTOs shall be posted alpha-numerically in the TO Library with other TOs. If filed away from the library, a cross-reference sheet will be used.

5.6.19.1 Posting File Copies. Provide copies of the TCTO to the work centers doing the work. Mark these TCTOs as “working copy/destroy when complete”. Do not place these working copies in a formal TO file IAW TO 00-5-15, paragraph 5.7.

5.6.20 Highlighting Prohibition. Except for individually assigned Flight Manuals (see AFI 11-215) and TOs maintained in reference (paragraph 5.1.5) or training (paragraph 5.1.6) libraries, highlighting of TO pages, as well as unauthorized annotations, marks, or changes to TO pages containing technical data, is prohibited. Highlighted pages and those with non-removable unauthorized markings must be replaced at the next TO change or revision affecting the page. Annotations to the title page and LEP are permitted (e.g., the date an increment is received by the library custodian).

NOTE

In some digital TO libraries, there is a function that allows annotations to be made in disconnected mode. This is permissible and must be adhered to IAW any local guidance.

5.7 POSTING MAJCOM, BASE AND UNIT SUPPLEMENTS.

MAJCOM, base and unit supplements are posted in alphanumeric sequence following the basic publication with MAJCOM supplements first and base supplements next.

5.7.1 Posting by ANG Units. ANG units file gaining MAJCOM supplements after any base supplements in the affected TO, marked for reference only.

5.7.2 MAJCOM, Base and Unit Supplements to Digital TOs. Digital files containing the MAJCOM, Base or Unit TO supplements are uploaded to a MAJCOM Internet server or Base LAN server. MAJCOM/Base digital TO users are then notified of the file location, and directed in their use.

5.7.3 Posting MAJCOM, Base and Unit Supplements to Paper TOs. TODOs will download the supplement file and print and reproduce sufficient copies of the attached supplement to satisfy local requirements. Indicate that a particular paragraph in the TO is supplemented by circling the paragraph number and writing the supplement number next to the paragraph in pencil.

5.8 CHECKING TECHNICAL ORDER ACCOUNT DISTRIBUTION RECORDS AND LIBRARIES.

NOTE

Rescinded and reference TO libraries are exempt from currency checks. The currency of TOs in training libraries is based on the criteria set forth in paragraph 5.6.6.6.

5.8.1 Weekly Checks. TODOs and TODAs must document the checking of all downloaded, non-ETIMS eTOs for currency every 7 calendar days, unless they are automatically notified of changes by the repository from which they were obtained.

5.8.1.1 Monthly Checks. ETIMS will be checked monthly for rescinded paper TOs and documented. Rescinded paper TOs must be pulled from active use within 30 days of the rescission date.

5.8.1.1.1 TODOs and TODAs are notified of ETIMS-derived eTO changes on the ETIMS home page under “New TOs that may be of interest to you” and “New Increments that may be of interest to you.”

5.8.2 Annual Checks.

5.8.2.1 Account Reconciliation. Organizational TODOs/TODAs must annually verify TOs on subscription are still required and the subscription quantities are correct in ETIMS.

5.8.2.2 TODO Account Information. TODOs must validate the following information within the prescribed time frames as follows:

5.8.2.2.1 Shipping Address. Shipping addresses must be validated every 90 days. Once the shipping address goes 90 past the required validation time period, the account will be inactivated. 365 days after the required validation time period, the account will have all ID quantities removed and the account number will be archived. Once this happens, a new account number will need to be established and all ID quantities will have to be reestablished.

5.8.2.2.2 Annual AFTO Form 43 Review. TODOs must annually review the information on their file copy of the AFTO Form 43 and forward updated AFTO Form 43 to the required address in Block 2 of the form. If during the review year, any change to include address, e-mail address, or add or remove TODO personnel this would require a revised AFTO Form 43. If there are no changes, TODO will annotate date of review in Block 10 of previously approved copy and forward copy to required address in Block 2 of the form.

5.8.2.3 TO Library Inventories. TODAs or TO library custodians must perform and document physical library inventories to ensure the TOs are complete and current (current basic and all increments posted). When there are too many TOs in a library to permit inventory during a single month, the TODA or library custodian may establish an incremental schedule to ensure a complete inventory of all TOs within the year. Such incremental reviews are considered “within the year” if completed within the proper month even if the completion date is more than 365 days since the last inspection. ETIMS account/sub-account POCs are able to schedule and document incremental reviews in ETIMS. Digital TO libraries contained on an eTool maintained IAW paragraph 5.6.7.2 are exempt from this requirement. (see paragraph 4.6.1)

5.8.2.3.1 Annual inventory documentation must identify the TOs inventoried, date performed and the name of the responsible individual. In regards to retaining documentation records, (paragraph 5.10.5). Perform the library inventory using an ETIMS “Master TO Report” listing tailored and provided by the servicing TODO/TODA. Perform a full LEP check of all paper TOs which have not had a full LEP check performed since the last annual library inventory. Update subscription quantities, update records, and requisition missing TOs and TO increments as required. If a full LEP is required, annotate the title page or LEP with the date (DDMMYY), reviewer initials, and/or employee number as well as any discrepancies IAW paragraph 5.8.3.2 of this TO.

5.8.2.3.2 Inventory discrepancies must be resolved. Update subscription quantities, update records, and requisition missing TOs and TO Increments as required. Accounts may not exceed a 3 percent threshold of discrepancies. TODOs are responsible for ensuring their account subscriptions and the actual inventory match. Accounts that exceed the 3 percent threshold discrepancy rate may be deactivated. See paragraph 6.3 prior to requisitioning missing increments.

5.8.2.4 Anytime a full (100 percent) LEP check is performed, it fulfills the requirement for the annual LEP check regardless of when the original annual LEP was scheduled (see paragraph 5.8.3).

NOTE

Blank pages might be omitted from digital TO files. This could create an apparent discrepancy between the LEP total number of pages and the electronic file page count. This is **NOT** a reportable discrepancy.

5.8.3 List of Effective Pages (LEP) Checks. LEP checks are a comparison of the page and change numbers on each page of a TO with the data on the LEP. LEP checks are mandatory when changes and revisions to paper TOs are posted. When changes are posted, only the changed pages must be checked. When a revision is posted, all pages in the TO must be checked. When a TO is received from the TODPS in response to a one-time requisition, a full LEP check must be performed to ensure the TO is complete and that all supplements are properly posted (see paragraph 5.6.14) and annotated (paragraph 5.6.16). For work package formatted TOs, the complete TO must be checked against the Master LEP page. When a Master LEP page is incomplete, each individual Work Package LEP will be checked.

5.8.3.1 LEP checks are not required on AF TMSS compliant HTML eTOs viewable/distributed via ETIMS. LEP checks on digital TO files are only required when the TODO/TODA electronically posts (merges) a digital TO change file into the baseline TO file, to verify that the two files were properly merged (no pages omitted, duplicated, inserted in the wrong place,

TO 00-5-1

or deleted pages left in the file). The LEP check must be performed using the TO intended viewing software application (do not print a copy of the TO file to perform the LEP check).

5.8.3.2 Annotate the title page or LEP with the date (DDMMYY), reviewer initials, and/or employee number (do not use SSN or partial SSN), as well as any discrepancies (missing pages, improper printing, etc.). For Work Package TOs, if a Master LEP is not present, annotate each individual LEP. For digital TO files on local drives or servers, enter this data in the Remarks window of the corresponding ETIMS record for the TO or in the TO Notes of the corresponding TO in the ETIMS database. When discrepancies are found on the LEP page, contact the TO Manager to determine if submission on an AFTO Form 22 is appropriate. Discrepancies on PTOs will be reported to the TO Manager's office indicated on the title page of the PTO.

5.8.3.3 LEP checks are required for commercial manuals with LEPs. Page checks are required for brief manuals or COTS manuals without LEPs and need to be documented with date and initials of person performing check.

NOTE

COTS TO users who becomes aware of a later version of the COTS manual applicable to their equipment (and not just to a later model/version of the equipment) should notify the ES/TCM so the later manual version can be procured, indexed, and provided to the TODO Accounts on subscription for the manual.

5.9 RESCISSION AND REINSTATEMENT/REACTIVATION OF TECHNICAL ORDERS.

TOs are rescinded for Air Force use when the information is no longer required, is incorporated in other publications, or the rescission date (for TCTOs) has expired. Some TOs rescinded for Air Force use are retained for Security Assistance Program use (TO 00-5-19). If a TO is listed as rescinded, but is still required to perform the unit mission, the TODO will immediately notify the TO Manager to have it reinstated/reactivated.

5.10 DISPOSITION OF TECHNICAL ORDERS AND FORMS.

TOs, TCTOs, tapes, cards, checklists, workcards and file documentation removed from active libraries will be disposed of as follows:

5.10.1 TOs needed for special programs or projects may be kept in "Rescinded" or "Reference Only" libraries.

5.10.2 If the TO is unlimited distribution, it may be placed in recycle or regular trash receptacles. Proprietary and limited distribution TOs shall be shredded, burned, pulverized, or consigned to a bonded recycling contractor who shreds or pulps the paper before resale. The shredded paper shall be recycled.

5.10.3 If the TO is classified, destroy in accordance with DoDM 5200.01 Vol 1-4 and AFI 16-1404 .

5.10.4 Some TOs and data are provided on digital media (floppy disks, CD/DVD, magnetic tape, etc.). Media containing unlimited distribution data may be recycled as is. Media containing restricted distribution data must be cleared before recycling: floppy disks and hard drives must be reformatted; magnetic tapes must be erased; and CDs/DVDs will have both surfaces scratched before recycling. Media containing classified data must be handled according to DoDM 5200.01 Vol 1-4 and AFI 16-1404. When canceling a Nonnuclear EOD TODO account, destroy the CDs/DVDs in accordance with established procedures.

NOTE

Use the provisions of MIL-HDBK-9660 for DVD management and formatting pending development of a publication specifically addressing DVDs.

5.10.5 TO library records should be addressed by the unit file plan, according to Air Force Records Information Management System (AFRIMS) Table 33-40 Rule 03.00 thru 04.03 , Table 33-38 Rule 27 as applicable, under the Air Force Records Disposition Schedule. Units may elect to maintain a cross-reference sheet in the file plan showing where these records are maintained. Unit administrative personnel should be contacted for assistance in setting up the TO portion of the file plan.

NOTE

The AFRIMS is exclusively accessed via the “Air Force Applications A-Z Index” listing on the AF portal.

5.10.6 TODOs must request TOMA guidance for disposition of extra COTS manuals.

5.10.7 When a function transfers from one activity to another, transfer of TO libraries is subject to the approval of the gaining activity.

TO SUPPLEMENT FILING GUIDE

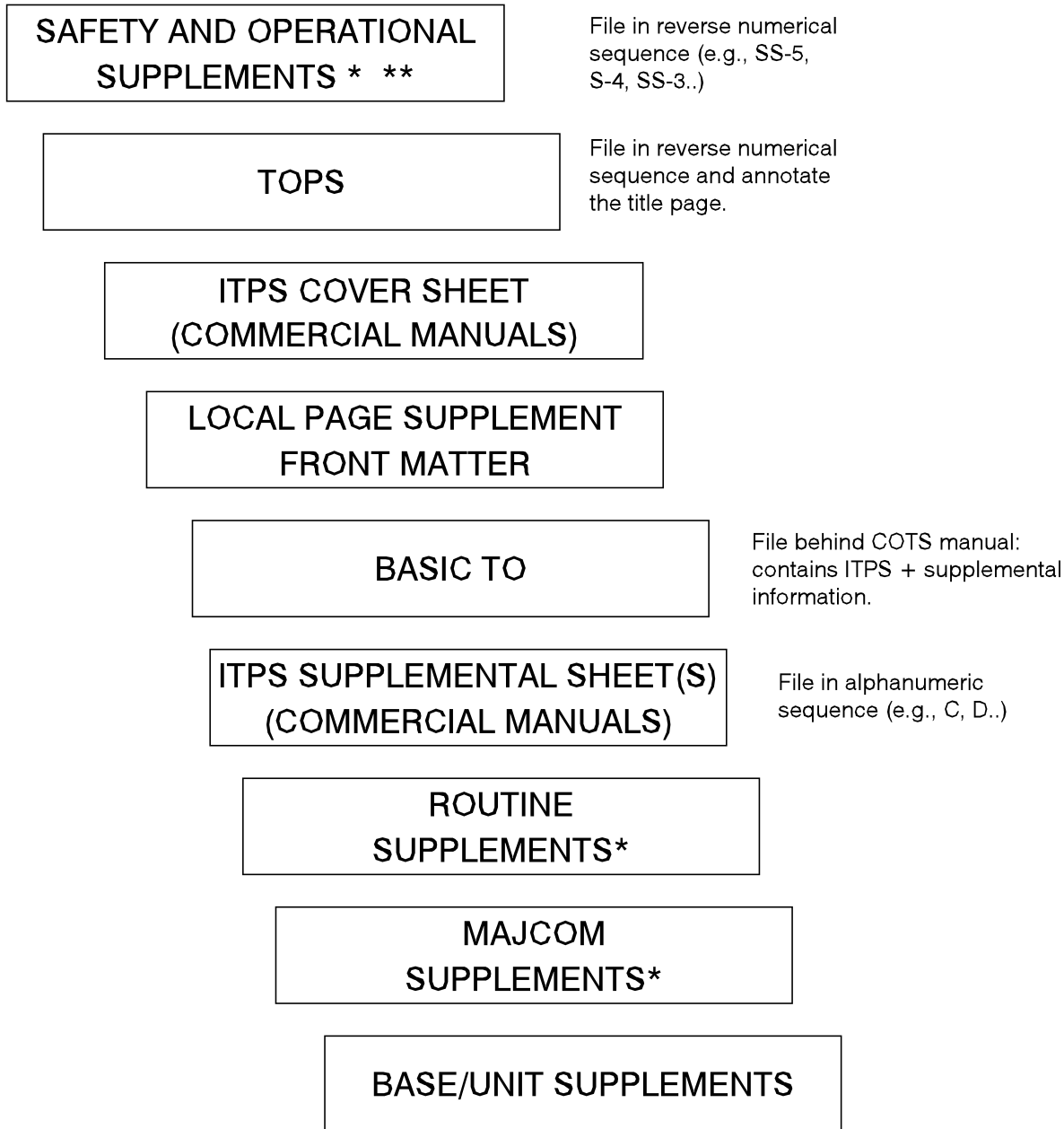

* Indicates Annotation on Title Page and All affected Pages.

** Safety and Operational Supplements will not be separated by type but will be filed in reverse numerical sequence as shown above. Older TOs may contain Safety and Operational Supplements bearing the same Numerical Supplement Number. In this case, the Safety Supplements will be filed in front of the Operational Supplements.

Interim Supplements will be filed as if they were Formal Supplements and then removed when replaced.

H9600742

Figure 5-1. TO Supplement Posting Guide

CHAPTER 6

ORDERING TECHNICAL ORDERS

6.1 GENERAL.

TODO personnel use ETIMS to order TOs for organization TO libraries to support operation and maintenance activities. Ordering TOs includes subscribing to future TO updates and requisitioning copies of the current TO version.

NOTE

Nuclear Weapon Center, Nuclear Related EOD and Nonnuclear EOD manuals are ordered according to Chapter 10.

6.1.1 Determining TO Requirements. Library users review the organization, mission, and equipment of the using activity to determine the TO and TCTO series numbers, the media type (i.e., ETIMS eTO or physical distribution media) and quantities required. Pertinent source documents are LOAPs, the ETIMS Catalog (sometimes referred to as the AF TO Catalog), and TCTOs. Known and anticipated programs, including training programs and transfer or receipt of air and space systems or equipment, should also be reviewed.

6.1.1.1 In keeping with the Air Force digital TO vision, digital (WA-1) TO subscriptions will be established for ETIMS eTOs instead of physical distribution TO (i.e., paper or CD/DVDs). However, there are some exceptions to mitigate impractical or unsafe work situations see TO 00-5-3, paragraph 5.4.3.

NOTE

- The TO number of TO versions distributed in digital format includes a media suffix code. While this suffix code is displayed by the ETIMS catalog and used in the ordering process, it does NOT appear on the title page or opening screen of the digital TO itself. The media suffix code for ETIMS eTOs is -WA-1 (e.g. TO 00-5-1-WA-1), for non-ETIMS eTOs is -WA-2, for CDs is -CD-n, and for DVDs is -DV-n. The “n” could be other than “1” if there is a set of CDs or DVDs with different classifications of TOs or just so many TOs that multiple CDs are required.
- Whenever activities require the continuation or restoration of physical distribution TO media (i.e., paper or CD/DVD), TODOs should alert TO managers to the extenuating circumstances/justification (e.g., explosive environments and certified laptops are unavailable).

6.1.2 Sponsor Approval TOs. TOs are designated as Sponsor Approval in the index record for the TO by the responsible TO Manager when initial subscription and distribution requests must be reviewed and approved prior to issue. These sponsor approval required TOs include Classified TOs; TOs with no distribution statements or distribution statement “F”; TOs containing “Proprietary” data; specialized publications (e.g., JNWPS, EOD, etc.); and commercial manual TOs with limited reproduction/distribution rights. Proprietary data may only be released to the contractor owning the proprietary rights unless written documentation has been provided by the proprietary rights owner to indicate otherwise. The TO Manager, in conjunction with the TCM, determines the need to screen distribution of other unclassified TOs. Orders for TO quantities in excess of the “Maximum Issue Quantity” (MIQ) automatically require sponsor approval.

6.1.2.1 Users enter their justification in the “Sponsor Approval/MIQ Justification” block when ordering their TOs in ETIMS. A notification is sent via ETIMS to the TO manager that is viewable from the ETIMS home page notification system letting the TO Manager know there are requests for sponsor approval TOs that require them to take action (either approve or disapprove). Once the TO Manager has taken action within the 10 day requirement, a reply notification will appear on the ETIMS home page of the requesting TODO(s).

NOTE

Identifying the quantity of TOs requested in the ETIMS sponsor approval block, as well as the quantity block of the ETIMS Subscribe/On-hand screen, will assist TO managers in not approving “duplicate orders”.

6.1.2.1.1 Commercial Vehicle Manuals. Subscriptions submitted for commercial vehicle manuals shall include the justification as well as the following information identifying:

- Vehicle Make
- Vehicle Model
- Air Force Vehicle Registration Number (Tag Number)
- Vehicle Identification Number (VIN)

6.1.2.2 Users can challenge the Sponsor Approval designation for a TO at any time by submitting a letter (e-mail) through the MAJCOM functional manager to the responsible TO Manager with specific rationale. The MAJCOM functional manager must endorse the requested change in designation.

6.2 ESTABLISHING SUBSCRIPTIONS.

6.2.1 General. TODOs use ETIMS to establish subscriptions for each TO required to support the unit mission, on behalf of their TODAs and library users. Subscriptions ensure automatic issue of future changes and revisions. TODOs determine and establish ETIMS subscriptions for the TCTO series header numbers applicable to their organization’s system/equipment. TODOs should subscribe to a single TCTO series header quantity. Local reproduction and one-time requisitions will be used to augment received TCTO quantities (paragraph 7.6). Whenever the subscription quantity of a TO is greater than the on-hand, a one time requisition transaction for the TO increment will be generated when the TODO selects “Update” then selects the “Send Orders” option. TODOs should monitor the status of their subscription orders by using the appropriate ETIMS order and/or report screen.

6.2.2 Unpublished TOs. TODAs will build and forward ETIMS subscription transactions to their TODO for new, unpublished TOs, needed to support mission activities. TODOs can send the order as soon as the new number is listed in the ETIMS TO Catalog.

NOTE

An “N” displays in the “Avail for Distrib” field of the Catalog for an unpublished TO.

6.2.3 Physical Media TOs. Whenever possible, cancel or reduce subscriptions for physical distribution TO media (i.e., paper and CD/DVDs). When they become available, establish subscriptions for corresponding ETIMS eTO or non-ETIMS eTO versions. If only a physical distribution TO media version is indexed, do not cancel the subscription for it in favor of a non-indexed eTO file.

6.2.4 Classified or Restricted TCTOs. When TCTOs of more than one security classification are published within a TCTO Series, a separate TCTO Series Header with the corresponding security classification will be established. Subscriptions for the classified TCTO Series Header will be established when required. The maintenance organization TCTO monitor will determine subscription requirements for depot level TCTOs.

6.2.5 Preliminary TOs (PTOs). A PTO is an unpublished TO used to support review of the new TO during the development process. PTOs are only distributed for specialized acquisition/training purposes IAW TO 00-5-3. All pages will be water marked across page to indicate this is a preliminary technical order for review. PTOs are not distributed through the TO System until the TOs are formalized. PTOs are listed in the ETIMS TO Catalog to allow TODOs to establish subscriptions ahead of time for new TOs required to perform the unit mission. If a unit requires a PTO to accomplish its mission, they must contact the TO Manager for copies.

6.2.6 Rescinded or Superseded TOs and TO Increments. When a TO/TCTO series is rescinded or superseded, it will be annotated with the corresponding code in the Pub Status field of the Tech Order Detail screen of the ETIMS TO catalog. TODO Account subscriptions for the TO/TCTO Series will be retained for one year, but new subscriptions or one-time requisitions will be prevented. If the TO/TCTO Series header is not reinstated within the year, the subscription will be removed from the TODO Account record. If the number is later reinstated, it will be annotated with the corresponding status

code and a new subscription must be established in ETIMS. Individual increments associated with a TO/TCTO series header are removed from ETIMS 120 days after they are rescinded or superseded. When a TO/TCTO is rescinded or superseded, it will be annotated by the TOMA with the corresponding code in the Pubs status field of the Tech Order Detail screen of the TO catalog.

6.2.7 Renumbered TOs. When a paper media TO is renumbered, existing subscriptions are transferred in ETIMS to the new TO number and the TO manager publishes a corresponding change page. TODOs will receive an ETIMS requisition transaction notice when the TO change page ships. Upon receipt, ETIMS TODOs should update subscription and on-hand quantities for both TOs and post the TO change pages to the renumbered TOs.

6.2.8 Reclassified TOs. When a TO classification level is increased, subscriptions will remain the same for TODOs authorized to receive the new higher classification (AFTO Form 43, Block 5). Subscriptions will be cancelled for TODOs not authorized to receive the new classification. TODOs must adjust ETIMS records as necessary. Decreases in classification have no effect on existing subscriptions.

6.2.9 Reinstated/Reactivated TOs. When a rescinded TO is reinstated within one year, the previous subscriptions are re-established. If the TO has been rescinded for more than one year, TODOs must establish new subscriptions in ETIMS. See TO 00-5-15 for reinstatement/reactivation of rescinded TCTOs.

6.2.10 Interim Technical Orders (ITO) and RACs. ITOs and RACs are developed by the TCM for the affected TO. If the TO is available as -WA-1, TODOs will download any interim TO content updates using ETIMS. If the TO is not available in -WA-1 format, TODOs will follow instructions in ETIMS catalog notes on how to obtain TO content updates.

6.2.10.1 Following foreign disclosure review, SAP/FMS customers are included in ITO distribution for systems and equipment that they operate. SAP/FMS customers without an active case are entitled to receive safety ITOs provided disclosure is authorized (see TO 00-5-19).

6.2.10.2 AFMETCAL, 813 Irving-Wick Dr West Ste 4M, Heath OH 43056-1199, DSN 366-5174 may use an electronic bulletin board system to issue routine Category 33K ITOs with distribution limited to USAF Precision Measuring Equipment Laboratories who require the changed calibration data. These interim changes will be published as Supplemental Manuals, and will be incorporated into the parent manuals during the next routine update.

6.2.11 ETIMS TO Update Follow-up. On hand TOs are considered current until superseding/replacing updates are received. If TO updates (i.e., ETIMS transactions with demand“*”) are not received within 45 days after the EDD for CONUS or OCONUS shipments, the TODO will follow-up with the TO Manager to determine the status of the transaction and annotate the TO title page with the missing update. Follow-up actions and unresolved issues will be recorded.

NOTE

The ETIMS Transaction Follow-up (i.e., Tx Follow-up) report identifies transactions older than a specified number of days.

6.3 REQUISITIONS.

ETIMS only requisitions the TO quantities for which the TODO is on subscription. When a new subscription is established, ETIMS generates two transactions: A One-time (demand “N”) to requisition the most current revision with any outstanding changes and supplements now, and a Subscription (demand “*”) to request any new Increments as they are published. Whenever the subscription quantity of a TO is greater than the on-hand, a one time requisition transaction for the TO increment will be generated when the TODO selects “Update” then selects the “Send Orders” option. Therefore, to requisition a single copy of a complete TO for replacement of a lost or irreparably damaged one, reduce the on-hand quantity by one. Unique document numbers are assigned to these transactions prior to the user sending the order. TODOs monitor the status of their orders with the ETIMS Order/Transaction Function.

6.3.1 Emergencies. Emergency requisitions are used when a TODO requires published, current TOs immediately because of a critical safety hazard or work stoppage condition; however, local reproduction (paragraph 7.6) may be used provided copies are available for reproduction and emergency requisitions will not meet time requirements. Additionally, TOs or TO increments less than 50 pages may be locally reproduced. Emergency requisitions cannot be used to establish subscriptions. Within ETIMS, identify an emergency requisition in the Emergency Justification block of the Subscribe / On-hand screen. Once the order is sent in ETIMS, the requisition will be on-demand filled by TODPS. If unable to fulfill the

TO 00-5-1

request, TODPS will notify ETIMS requisition is in HELD status. TO Managers normally have 7 calendar days to rectify held requisitions so DDR should be submitted as soon as held status is received.

6.3.2 Preliminary TOs. Preliminary TOs cannot be requisitioned (paragraph 6.2.5).

6.3.3 Interim TOs. Interim TO notifications are received through link on ETIMS home page. ITCTOs/ITOs can only be obtained based on instructions in catalog notes in ETIMS. Submit DDR if catalog notes do not provide required information needed to obtain Interim TO.

6.3.4 FOIA. Freedom of Information Act (FOIA) requests are submitted to the FOIA Office at the TO Manager base (see <http://www.foia.af.mil/>) and are processed according to the AF Supplement to DoD 5400.7-R AFMAN 33-302, *DoD Freedom of Information Act Program*. TOs will be withheld from FOIA release if the technical data meets the non-releasability criteria of DODD 5230.25, Withholding of Unclassified Technical Data from Public Disclosure.

6.3.5 Inactive TOs. Inactive TOs (rescinded, replaced, renumbered) may be requested from the TO Manager who was prime on the TO before it became inactive. The TO Manager determine releasability in coordination with the previous content management activity, and provide the TO or advise the requester of the reason for refusal.

6.3.6 ETIMS One-Time Requisition Follow-up. If ETIMS one-time requisitions (OTR) are not received within 15 days of receiving a 'Shipped' status, TODO will submit a "Missing or Damaged Shipment" DDR requesting DLADS follow-up. If held status is received TODO should submit a "TO not loaded to TODPS correctly" DDR. The following actions should be taken if response to DDR is requisition is on hold due to lack of funding: 1) immediately notify Group CC or equivalent through Chain of Command that access to physical media format of the TO is not available; 2) inform their MAJCOM CTOM representative and request immediate assistance (see paragraph B.4.4); 3) if a -WA-1 version of the TO is indexed in ETIMS, subscribe and, if necessary, locally print a copy of the TO to avoid a work stoppage situation; 4) if a -WA-1 version of the TO is not indexed in ETIMS, request the TO manager provide a copy of the digital file by one of the alternate methods in TO 00-5-3, paragraph 10.9, and, if necessary, locally print a copy to avoid a work stoppage situation.

NOTE

- The ETIMS Transaction Follow-up (i.e., Tx Follow-up) report identifies transactions older than a specified number of days.
- Transactions in Shipped and BA status over 90 days will be cancelled.

6.3.7 One-Time Requisition of Fleet Vehicle Manuals. Whenever the Air Force procures new fleet vehicles, maintenance manuals are typically delivered with the new vehicle. Concurrent with the procurement, the manuals are indexed in ETIMS to support future one-time requisition requests. When maintenance manuals are delivered with a new vehicle, the TODO must establish a subscription (ID Only) for the newly indexed TOs and record on-hand quantity. If at a later date a one-time requisition (OTR) is necessary, a sponsor approval justification will need to be submitted with the ETIMS OTR identifying:

- Vehicle Make
- Vehicle Model
- Air Force Vehicle Registration Number (Tag Number)
- Vehicle Identification Number (VIN)

6.3.7.1 Direct questions regarding the processing of one-time requisition to the TO manager listed on the detailed information page of the TO index.

6.4 CONTRACTOR REQUIREMENTS.

NOTE

GOCO AF base or organization TODOs are authorized to establish subscription requirements and request TO distribution as an AF activity.

6.4.1 TOs Required for Support of Government Weapons Systems Acquisition Contracts. TOs required as government furnished property in aircraft delivered to the AF by contractors shall be obtained by requisition through the GAA. Separate requisitions, covering up to a 3-month requirement, will be submitted for aircraft libraries and will be clearly marked "For Aircraft Libraries."

6.4.1.1 TOs Required in Support of U.S. Government Contracts. These TOs shall be requisitioned through the GAA. The requesting contractor must furnish an approved DD Form 2345, U.S. Government Contract Number under which the data will be used, and the Government Contracting Officer name or a GAA who can attest to the data requirement.

6.4.2 Foreign Contractors Supporting U.S. Program Offices. US Program Offices contract with foreign firms to improve the readiness and reduce the sustainment cost of overseas-based, US aircraft and equipment. When ordering and distributing the TOs required by these foreign contractors, US personnel must ensure compliance with the Arms Export Control Act (AECA) and STINFO policy. Refer to AFI 61-201, DoDD 5230.25, and TO 00-5-19 to ensure strict adherence to Foreign Contractor TO Support policies.

6.4.2.1 The US program office will establish contractor (E*) TODO accounts IAW Chapter 4 to order and redistribute TOs to their foreign contractor, including entering the contract numbers and associated cancellation effective dates in Block 4h of the AFTO Form 43. TODO personnel must be US Citizens, or equivalent IAW AFI 61-201. Ideally, the primary TODO will be assigned at the foreign contractor facility and the required TOs will be shipped to the TODO's APO/FPO mailing address. In all cases, the "ship to" address must be identified in Block 3 of the AFTO Form 43.

6.4.2.2 The TODO must work closely with the program office and foreign contractor TO library custodian to ensure subscriptions are established for the required TOs/TCTO Series Headers, required TOs are provided in a timely fashion, TOs are properly posted, TO libraries remain current and accurate TO records are kept. The program office, in coordination with the TODO, will provide the foreign contractor TO library custodian with the written operating instructions to be used to manage the TO library and ensure the library custodian is trained and qualified to manage the library. Because foreign contractors are unable to access the TO library custodian training resources listed in Annex C as they are unable to obtain AF portal accounts, the AF program offices should ensure TO library custodians receive documented, comparable training.

6.4.2.3 U.S. Government Activities at the overseas location shall keep organic TO requirements separate from country or contractor requirements. Organic requirements will be established in the same manner as any other U.S. Government activity.

6.4.3 Requests Related to Procurement and Competition Advocacy Announcements.

6.4.3.1 TO requests should be submitted to the announcing contracting office and specify the solicitation and specific TO numbers. The announcing office must verify the bidder is an authorized contractor eligible to bid on the Request for Proposal. If so, and the TOs requested are required for the solicitation number quoted, the contracting office will print, sign and retain a copy of the TO request. Approved requests shall be submitted to the responsible PM or SCM office for review of TO releasability and processing of the TO request. TOs or extracts from TO catalogs releasable under provisions of AFI 61-201 shall be provided to the prospective bidders. TOs that are not releasable shall be made available for review in a bidder library at the buying location.

6.4.3.2 Although qualified U.S. contractors may request TOs outside the procurement channel using paragraph 6.4.1 or paragraph 6.4.3 procedures, they are encouraged to submit these requests IAW paragraph 6.4.2.1 through the announcing office so that the office is aware of the need and can establish TO Manager response dates consistent with the announcement closing date. Paragraph 6.4.1 or paragraph 6.4.3 procedures are not subject to processing times tied to closing dates. TOs will be mailed only to U.S. (including APO and FPO) addresses.

NOTE

A listing of qualified U.S. contractors and their assigned codes can be obtained from the Defense Logistics Information Service (DLIS) at 1-800-352-3572, or at the DLIS web site, <http://www.dlis.dla.mil/jcp/> (click on "Search" on the left side).

TO 00-5-1

6.5 NON-RELEASABLE USAF TECHNICAL ORDERS FOR DIRECT CONTRACTOR SUPPORT OF AN FMS PROGRAM.

6.5.1 Security Assistance Program (SAP)/Foreign Military Sales (FMS) Customers. TOs for these customers are ordered and distributed IAW TO 00-5-19. U.S. Security Assistance Organizations (SAO) will provide assistance as required.

6.5.2 TO Requests from Foreign Companies and Individuals. A request for a USAF TO from a foreign company or individual that is not SAP or U.S. Government Activity support related must be submitted through the embassy to the Foreign Disclosure Office (FDO) at the appropriate proponent location. A U.S. based foreign contractor representative responding to a procurement or competition advocacy announcement must submit the request to the announcing office for processing through the FDO to the TO Manager.

6.5.3 TOs to Support Non-USAF-Managed FMS Contracts and Direct Sales Programs with Follow-on FMS Contracts. Contractors might need USAF TOs to perform a service contracted directly with a SAP or other foreign country. This requirement must be established by the country and charged to the appropriate TO publications case. The country may obtain the required TOs through the assigned TODO or designate the contractor as the country agent and request an FMS TODO Account code to the contractor and use the country TO publications case for billing purposes. TOs will be shipped directly to the contractor when the second method is used. For more information, see TO 00-5-19.

6.5.3.1 When Country Standard TOs (CSTOs) are required for the support of a direct service contract with a country, the country should request the TO Manager that manages the CSTO contract to amend the Stock, Store, and Issue (SSI) contract as necessary to supply CSTOs to the service contractor. A copy of the request should be forwarded to the country's case manager at AFSAC Directorate. If the SSI contractor needs shipping labels, an FMS TODO Account code must be assigned to the service contractor. For more information, see TO 00-5-19.

6.5.3.2 For a direct sales program requiring USAF TOs to be delivered to a foreign government, the country should establish requirements for USAF TOs directly with SATOP's country Assistance Team. An FMS TO publications case must be established if the country does not have one.

6.5.3.3 Under no circumstances will the contractor be authorized to requisition USAF TOs under a USAF contractor TODO Account code for the support of a non-USAF-managed service contract or direct sales program. This action could result in unauthorized disclosure of export-controlled information and violate public law on recouping costs.

6.5.3.4 Certified US contractors with appropriate export licenses should be provided releasable TOs to support the repair/delivery of parts and services in a direct commercial sales contract with a foreign government. In this case, the TOs must be safeguarded from inadvertent release to the foreign customer and only the parts and services are to be released, IAW the export control license. Fees for TOs and data released for use by domestic purchasers will be limited to the direct cost of search and reproduction in accordance with DOD 7000.14-R, Volume 11A, Chapter 4, User Charges.

6.6 OTHER REQUESTS.

If one of the above sections apply, you must use it.

6.6.1 Public Releasable TOs. Some distribution A Technical Manuals can be viewed and downloaded at the following sites; <http://www.robins.af.mil/library/technicalorders.asp> and <http://www.tinker.af.mil/technicalorders/index.asp>.

6.6.2 Other Government Agencies Need for TOs. Other government agencies with a need for TOs should order them through their TODO; if they do not have a TODO, the government agency can contact the primary TO manager of record listed in the AF TO catalog.

6.6.3 FOIA Request. When none of the other provision in Chapter 6 apply, requests for TOs can be made via the FOIA request process. Note: Contractors and subcontractors requesting TOs in support of a government contract must use the procedures in paragraph 6.4. FOIA request are submitted per the guidance at <http://www.foia.af.mil>.

6.6.3.1 Fees for TOs and data released for use by domestic purchasers will be limited to the direct cost of search and reproduction in accordance with DOD 7000.14-R, Volume 11A, Chapter 4, User Charges (<http://comptroller.defense.gov/fmr>).

6.6.4 Commercial Manual Request. A request for a commercial manual that has been assigned a TO number shall be denied and the requester provided the name and, when available, the address of the commercial concern named on the manual. (Commercial manuals adopted as USAF TOs are exempt from public release under AFI 61-201 and the AF Supplement to DOD 5400.7-R.).

CHAPTER 7

DISTRIBUTING AND LOCALLY REPRODUCING TECHNICAL ORDERS

7.1 TECHNICAL ORDER DISSEMINATION CONTROL.

Release and distribution of TOs and other technical data is controlled to prevent unauthorized disclosure. The following notices and warnings will be found on all preliminary and formal TO title (or T-2) pages when required by the TO contents:

7.1.1 Distribution Control Notices. The distribution control of all preliminary and formal technical data, except for non-TO-numbered commercial manuals, is provided by application of Distribution Statements selected IAW DoDI 5230.24 (Appendix E). Included in the statement is the office symbol to contact if further dissemination of the tech data is required. The notices or statements are on TO title or T-2 pages, and on digital media labels and digital file title or opening screens (see MIL-HDBK-9660). If the reason for the distribution statement is "Proprietary Data", there may also be a title page statement on the government's rights to distribute, copy, use, and modify the data. If local technical data is generated, apply the parent document distribution control markings to these derived documents, unless the derived document's purpose and a subsequent content review confirm it is unrestricted.

7.1.2 Disclosure Notices. A disclosure notice is used on all classified and unclassified TOs approved for release to a foreign government, except those assigned Distribution Statement A (MIL-STD-38784, Standard Practice for Manuals, Technical: General Style and Format Requirements). The disclosure notice will be on all classified and unclassified nuclear TOs.

7.1.3 Export Control Warning. An export control warning IAW AFI 61-201 is used when the data is restricted from foreign distribution under provisions of the Arms Export Control Act. You must include the reason *Export Controlled* in addition to other distribution reasons when the data will be export controlled.

7.1.4 Disposition and/or Destruction Notice. A Disposition Notice or a Handling and Destruction notice is used for technical documents IAW MIL-STD-38784. See paragraph 5.10 for specific disposition/destruction procedures for unclassified paper TOs and digital media.

7.1.5 Security Classification. DoDM 5200.01 Vol 1-4 and AFI 16-1404 markings apply to Confidential or Secret TOs. Additional DoDM 5200.01 Vol 1-4 and AFI 16-1404 markings apply to TOs that contain Restricted Data (RD), Formerly Restricted Data (FRD) or Critical Nuclear Weapons Design Information (CNWDI).

7.1.5.1 If any Air Force activity has reason to believe that security considerations support the reclassification of a TO, follow the procedures for requesting reclassification outlined in DoDM 5200.01 Vol 1-4 and AFI 16-1404.

7.1.5.2 The security classification of each classified TO is indicated in the ETIMS TO Catalog. Use of classified titles is typically avoided.

7.1.5.3 Release of Classified TOs. Do not release classified TOs to foreign nations or foreign personnel without controlling DoD office approval. Ensure U.S. personnel have the proper security clearances and need-to-know before releasing classified data to them.

7.1.6 For Official Use Only (FOUO). FOUO is no longer authorized for use in marking technical data. It was replaced by distribution statements. If you receive technical data marked FOUO, contact the TO Manager to determine the distribution statement applicable to the item.

7.1.7 Controlling Distribution of Technical Orders. TO Managers must control the distribution of TOs to eligible recipients IAW DoDM 5200.01 Vol 1-4 /AFI 16-1404, AFI 61-201, and for reasons specified in this TO. For Air Force TO System implementation of the STINFO Process, TODO may represent "Controlling DoD Offices (CDO)" and may make primary distribution to any accounts and sub-accounts based on mission requirements. If proprietary TOs must be distributed to GOCO Accounts, the contractor personnel must have signed non-disclosure agreements on file with their company. CDO role for TOs and drawings is normally delegated to the TCM (ES or Engineer), who determines initial (primary) distribution lists and approves or disapproves various one-time requests that require review (Ref. DoDI 5230.24). TODO must coordinate with CDO for approval for export controlled data. A TODO is not the CDO.

7.2 TECHNICAL ORDER SHIPMENTS.

TO Managers are responsible for the accuracy and timeliness of shipments.

7.2.1 Initial Distribution (ID). ID is the first distribution of a TO, TCTO, change, revision, or supplement after publication. ID is made based on subscriptions (Chapter 6). Nuclear Weapon Center, Nuclear Related EOD and Nonnuclear EOD TOs are distributed according to Chapter 10.

7.2.2 ID Mailing Methods. Distribution through TODPG is based on complexity level, certification of DLA facilities, concurrent release requirements and classifications of TOs. TO managers make ID via expedited shipment of all immediate or urgent Nuclear Weapon TOs.

7.2.3 Classified TO Packaging. Procedures for packaging classified TOs are provided in DoDM 5200.01 Vol 1-4 and AFI 16-1404. TO managers should not intermix classified and unclassified TOs; however, a shipment of a classified TO may include its corresponding unclassified changes and supplements. Labels for classified TO shipments should not show the TO classification.

7.2.4 Multiple Package Shipments. When more than one package is needed, each is identified (for example: "1 of 3", "2 of 3"). For classified TOs, the record portion of the mailing label is placed in the first package.

7.2.5 Receipt of Secret or Classified TOs. All shipments of secret TOs will be accompanied by an AF Form 310, *Document Receipt and Destruction Certificate*, or approved equivalent. Receipts must be signed and returned to office identified in Block 2 of AF Form 310 immediately after verification of shipment contents. Failure to return the signed copy within 30 calendar days (45 calendar days of overseas TODOs) from date of dispatch constitutes a violation of security requirements. All shipments of TOs will be opened promptly and checked to ensure the TO number and the quantity agree with that shown on the mailing label. All shortages will be reported to office identified in Block 2 of AF Form 310 immediately, with an information copy to the TO Manager. The sender must then initiate a security investigation IAW AFI 16-1404.

7.2.6 Suspected Lost Classified TO Shipments. TODOs or other personnel who suspect classified TO shipments to be lost or accessed in transit should notify the TO Manager. The TO Manager will notify sending office and sending office must then initiate a security investigation IAW AFI 16-1404.

7.2.7 Export-Controlled TO Shipments. When mailing export-controlled TOs outside the U.S. DoD TO Managers ensure the shipment is accompanied by the *Notice to Accompany the Dissemination of Export-Controlled Technical Data*, either paper or digital read-me-file to the recipient as set forth in DoDD 5230.25 Enclosure 5. Export-controlled TOs must not be released to U.S. DoD contractors unless the recipients have a valid DD Form 2345 and are certified with the appropriate authorities IAW AFI 61-201 and DoDI 5230-24.

7.2.8 Remote Units. In certain instances, normally in remote locations, units require direct distribution of TOs. In such cases the host base and AFLCMC/LZPTP may agree to assign a separate TODO Account to the remote unit to allow distribution directly to the remote unit.

7.2.9 Deploying Units. When deploying for six months or less, units will normally receive TODO support from the parent installation. For longer periods, units may request establishment of a TODO at the deployment location or request accession of an account already in place. Requests should be submitted 30-60 days before the desired effective date.

7.2.10 Release of TOs in Support of Litigation. The TO Manager may only release TOs in support of litigation when the U.S. Government is a party to litigation, and then only by authority of the Judge Advocate (JA) office. Requests must clearly state that the government is a party to the litigation. For civil litigation (not involving the U.S. Government) coordinate TO release with the JA IAW AFI 51-301, Civil Litigation.

7.2.11 TO 00-105E-9, Aerospace Emergency Rescue and Mishap Response Information (Emergency Services), Distribution to Civilian Fire Departments. Civilian fire departments who might have to respond to military aircraft accidents may obtain this TO by first registering at <http://www.dodffcert.com/00-105E-9/index.cfm>. If you are not authorized access to this site, contact AFCESA/CEXF, DSN 523-6150, e-mail: HQAFCESA/CEXF@tyndall.af.mil. Civilian fire departments do not require an Air Force TO account to obtain this TO. After registering for the TO on the AFCESA website, TODOs should also subscribe to TO 00-105E-9-WA-2 in ETIMS. This will ensure they are alerted within ETIMS whenever a new TO increment is uploaded to the AFCESA site.

7.2.12 Replacement Pages. TOs and TO increments distributed with missing or misprinted pages may be corrected by redistributing the missing/reprinted pages using an “Errata Cover Sheet” through TODPS and sending to original distribution list. The Errata Cover Sheet (see Glossary) will provide instructions to insert/replace the pages into the affected TO(s). This method will not be used to replace pages when the content of the data must be changed. Because errata packages do not change TO data or change numbers, the packages are not numbered and indexed in ETIMS. LEP annotations documenting the missing/damaged pages will be erased. TODOs should enter a comment into the corresponding ETIMS TO Note Field documenting the purpose of the errata sheet. EXCEPTION: FMPs may be supplemented using replacement pages IAW AFI 11-215.

7.2.13 Reporting Packaging and Shipping Problems. Matters relating to packaging and shipping, including faulty packaging, and postal registration numbers, will be documented as “Missing or damaged in Shipment” category, ETIMS Data Discrepancy Report (DDR). The package shipping label must be included for these issues to be resolved. Once the user has filed a DDR, the label can be e-mailed to the Air Force Technical Order Field Support Team at af.etimstofst@us.af.mil. For Nuclear Weapon Center, Nuclear Related EOD and Nonnuclear EOD TOs contact to TO Manager.

7.2.14 Reporting TO Print Quality Problems. Include TO Number, TM Account and description of the problems using the ETIMS DDR process. The package shipping label must be included for the issue to be resolved. Once the user has filed a DDR the label can be e-mailed to the Air Force Technical Order Field Support Team at af.etimstofst@us.af.mil. TO Managers will take appropriate action to correct the problem.

7.3 ACTIONS REQUIRED UPON RECEIPT OF TO SHIPMENTS.

7.3.1 TODOs will open all shipments promptly and verify that the TO number and quantity agree with that shown on the shipping label and document receipt in the ETIMS. TODOs will validate their TODO Account code and shipping address is correct and update if needed (see Chapter 4 for instructions on updating TODO shipping addresses).

7.3.1.1 When a shortage exists, enter the words “Shortage, quantity received (number)” on the face of the label. Contact the responsible TO Manager for shipping disposition instructions.

NOTE

TODOs shall not return TOs without the approval of the TO Manager.

7.3.1.2 When extra copies are received they may be held. Contact the TO Manager for disposition instructions before destroying extra copies.

7.3.1.3 When extra copies of classified TOs are received, contact the TO Manager for disposition instructions. Store extra copies in an appropriate location pending disposition instruction.

7.3.1.4 When misdirected or incorrect TOs are received, contact the TO Manager for disposition instructions. Misdirected shipments of unclassified TOs will be forwarded to the correct address when possible.

7.3.1.5 When classified TOs are received, sign the classified document receipt and promptly return it to the address shown on the receipt see paragraph 7.2.5.

7.3.1.6 When Immediate/Emergency ITO notifications or e-mail messages are received, forward them with “read receipts acknowledged” within 2 hours. Forward Urgent notifications or e-mail messages within 24 hours.

7.4 RECEIPT OF INTERIM TECHNICAL ORDERS (ITO) AND RAPID ACTION CHANGES (RAC).

7.4.1 TODOs who discover they are not receiving ITO ETIMS notifications should advise the TO manager listed in the ETIMS TO catalog. TODOs should also take time to ensure the organizational email address is listed correctly for the account and make necessary changes. If changes are made, send an updated AFTO Form 43 with those changes.

7.4.2 TODOs will distribute copies of incoming ITOs or notification e-mails to all affected base activities and subordinate TODAs. ITOs with limited distribution (Distribution Statements B-F or export controlled data, Appendix E) may be redistributed using PKI encryption. Subject line of e-mails with limited distribution TOs attached must begin with FOUO.

7.5 RECEIPT OF FORMAL TIME COMPLIANCE TECHNICAL ORDERS (TCTO).

7.5.1 When formal TCTOs not applicable to the unit are received, document the receipt and save item to hard drive/server in case of future need or to show inspector/QA personnel. If keeping paper copies, track not applicable TCTOs on separate spreadsheet as to why not applicable so that information can be readily available for a inspectors/QA personnel. TODOs will keep the applicability portion (typically first page) of the TCTO as verification that the TCTO is not applicable (referencing spreadsheet) and file along with the applicable TCTOs. If tracking not applicable TCTOs by ETIMS, the TODO has the option to input N/A TCTOs and the reason why they are N/A. This data can be exported into a file and presented to an inspector when requested.

7.5.2 When formal TCTOs applicable to the unit are received, document receipt in ETIMS. If insufficient quantities are received, either one-time requisition the necessary copies or use local reproduction (see paragraph 7.6).

7.6 LOCAL PRINTING AND REPRODUCTION OF PAPER MEDIA TECHNICAL ORDERS.

Air Force activities may locally print or reproduce unclassified TOs or portions of TOs not under any restrictions such as limited rights or other special controls, under the following conditions: TO managers are responsible for supplying TOs in the required media versions, they will not direct units to use local printing or reproduction to satisfy routine requirements. Classified and limited distribution TOs or portions of TOs may be printed or reproduced under the same conditions, as long as the activity complies with the rules in DoDM 5200.01 Vol 1-4, DoDIs 5230.24, and DODD 5230.25, and AFI 61-201. If color is critical to understanding the TO data, local printing or reproduction must be in color. The distribution markings and controls of the complete TO apply to any extracts. Since the distribution markings are only displayed on the TO title page, include the TO title page whenever printing or reproducing TO extracts. Interim TO ETIMS notifications or e-mail messages and RACs must be printed or reproduced locally. All locally-printed copies of TO extracts will be stamped or written in ink with the reproduction date on the copy of the TO title page and destroyed after use. EXCEPTION: In the event that a TO extract will be used for an extended period of time, local policy will be established for ensuring currency.

7.6.1 TO Using Organizations may use local printing or reproduction to prevent work stoppages due to missing or damaged TOs provided copies are available and emergency requisitions (paragraph 6.3.1) will not provide replacement copies in the time required. EXCEPTION: TOs or TO increments less than 50 pages may be locally reproduced. MAJCOM supplements may be used to increase this limit to allow for greater flexibility.

7.6.2 Only current TOs or portions of TOs may be downloaded, printed or reproduced for O&M use. The individual who downloads or prints a TO from a web site, local server or CD/DVD is responsible for ensuring its currency. Users of proprietary, vendor libraries must comply with the restrictions listed in the user access agreement and with the Government License Rights on the TO title pages. The user who prints out the TO extract must print the title page in addition to their extracts and include the following documentation on it: initials, date printed, and date verified current. Technicians will not use TO extracts unless they have been verified current within the last 7 calendar days; when re-verifying currency, add your initials and the date verified current. MAJCOMs and lower organizations may establish stricter limits and/or require the use of employee numbers, or depot production stamp.

7.6.3 TOs or portions of TOs printed or reproduced from superseded versions or reproduced for non-O&M use will be marked "FOR REFERENCE ONLY", and will not be used with operational equipment.

7.6.4 TO Changes may be printed or reproduced from digital or paper TO copies obtained locally or from other units with the same equipment.

7.6.5 TOs will not be locally reproduced for use outside the U.S. government or authorized government contractors except when authorized by the responsible TCM and FDO.

CHAPTER 8

CROSS-SERVICE UTILIZATION OF TECHNICAL PUBLICATIONS

8.1 GENERAL.

This chapter contains policy and procedures on interservice distribution of technical publications not integrated into the Air Force TO system. Air Force, Army, Navy, Marine Corps, and Defense Logistics Agency (DLA) will exchange technical publications as provided for in AFI 20-118.

8.2 OBTAINING ARMY PUBLICATIONS AND RELATED FORMS.

8.2.1 Army Technical Manual (TM) Accounts. Permanent distribution accounts are no longer established for other than Army agencies. When possible, electronic forms and TMs should be used in lieu of hard copies. The Army index for electronic forms/TMs is DA PAM 25-30, Consolidated Index of Army Publications and Blank Forms, and can be found at the Army Publishing Directorate (APD) website: <http://www.apd.army.mil>. Numerous electronic forms/publications are available for download from the APD site. Links to other sites for additional electronic media can also be accessed from the APD website.

8.2.2 Subscriptions. A subscription is available only for online Electronic Technical Manuals (ETMs) hardcopy TM subscriptions are no longer available.

8.2.2.1 Establish an ETM subscription at website: <https://www.logsa.army.mil>. On ETM search screen and View Current Notifications, enter email address. This will allow users to be notified when ETMs has a change or revision.

8.2.2.2 View or download ETMs at website: <https://www.logsa.army.mil/> under Publications “ETMs Online”.

8.2.2.3 To access non-Distribution “A” ETMs an Army Knowledge Online (AKO) user account will need to be created at AKO website <https://login.us.army.mil/suite/login>. Air Force users will require an Army Sponsor to establish an account. The Sponsors AKO User ID is required to create the account. Programs without an Army Sponsor can request assistance from afmc.ezntp.afto43@us.af.mil. Once the AKO account is approved, a System Access Request (SAR) is required to gain full access. To complete the SAR go [https:// www.logsa.army.mil](https://www.logsa.army.mil) select the LIW portal tab then follow the “New User” registration instructions to complete and submit the SAR. Once approved user will receive an e-mail to login. (Contractors cannot access Distribution ‘B’ Government Agency only publications. They can only be viewed by Government officials.)

8.2.3 Procedures to Requisition Army TMs.

8.2.3.1 The DA Form 4790, *Certification for Distribution of Publication(s) in Support of Government Contract*, is used to request Army TMs on a one-time basis when hard copies are necessary to support interservice requirements. Requests are limited to 25 copies of an individual title, not to exceed 250 copies (any combination of publications). DA Form 4790 can be located at: <http://www.apd.army.mil>, and “Search DA Forms”. (See Table 8-1 Instructions for Completing DA Form 4790.)

Table 8-1. Instruction for Completing DA Form 4790

Block	Instructions
Block 1 - Date	Enter the day the form is being filled out. Format: DD/MMM/YYYY
Block 2 - To	Enter below Address to Media Distribution Division: Media Distribution Division-STL ATTN: LMB/Customer Service 1655 Woodson Rd St. Louis, MO 63114-6181
Block 3 - From	Enter organizational address. Also include any account number or identifier that your service uses to determine your eligibility to request publications (i.e. TODO, ETIMs account, etc.)

Table 8-1. Instruction for Completing DA Form 4790 - Continued

Block	Instructions
Block 4 - Certification	Leave Blank not applicable for Interservice requests.
Block 5 - Classified Publications	Enter the publication number, nomenclature and quantity (not exceeding 25 copies) required. Requests for classified pubs MUST be accompanied by a digitally signed memorandum from the organization's Security Officer validating the requestor has the proper clearance AND equipment to receive and safe-guard classified publications.
Block 6 - Unclassified Publication	Enter the publication number, nomenclature and quantity (not exceeding 25 copies) required. Enter one publication per line on the form. A continuation sheet may be attached to the DA Form 4790 if needed.
Blocks 7 - Ship to Address	Enter the delivery address. The address should be validated against the USPS address database. The address format is four lines not exceeding 25 character/spaces per line, no punctuation and only approved abbreviations. A named point of contact name and a complete phone number should be included for use by the delivery company.
Block 8 - Contract Number	Enter requestor's e-mail address.
Block 9 - Expiration Date	Leave blank – not applicable for Interservice requests.
Block 10 - Typed Name of Contracting Officer	Enter requestor's name.
Block 11 - AUTOVON Phone No.	Enter requestor's phone number. Indicate DSN or Commercial number.
Block 12 - Signature	Enter requestor's digital signature (required).
Block 13 - Typed Name of Pub Control Officer	Leave blank. NOTE: At this time there is no field for the Inter-service Publications Liaison's signature. However, a digitally signed e-mail forwarding the DA Form 4790 to the LOGSA Proponent will be acknowledged as concurrence with the request.

8.2.3.2 For a single use one time requisition of Army TM, not exceeding 25 copies of an individual title, prepare a DA Form 4790. Once completed, e-mail the DA Form 4790, as well as the required delivery date, a justification and impact statement if the order is not filled, to the Interservice Publications Liaison at: aflcmc.ezgtg.afto43@us.af.mil. The Interservice liaison will forward the DA Form 4790 request to Army proponent (LOGSA) for processing. (Note: For AF Contractors, their Government Contracting Officer is required to complete and submit the form 4790 for Contractor requests of Army TMs.)

8.2.3.3 Army proponent (LOGSA) will review the DA Form 4790 and make a determination of release for proponenty of Distribution B, C, D, E, F, and X publications, and will perform requisite coordination. After receiving permission to release TMs, LOGSA will forward approved DA Form 4790 to Media Distribution Division (MDD). MDD's Customer Service will establish a temporary account to process the one-time order for release of no more than 25 copies of each title to the requestor. (Note: Contractors cannot access Distribution "B" Government Agency only publications.)

8.2.3.4 Funds are required for TM requests in excess of 250 copies or for recurring publications requirements. In these situations, coordination should be made directly with APD Print Division; a Military Interdepartmental Purchase Request (MIPR) is required.

8.2.4 References.

AR 25-36, *Interservicing of Technical Manuals and Related Technology*, 12 May 1989
 AR 25-30, *Army Publishing Program*, 03 Jun 2015
 DA PAM 25-30, *Consolidated Index of Army publications and Blank Forms*
 DA PAM 25-40, *Army Publishing Program Procedures*, 03 June 2015
 AFI 20-118, *Instructions for the Interservicing Of Technical Manuals and Related Technology Program*, 14 November 2014

8.2.5 Procedures for Other Components to Recommend Changes to Army Single-use TMs. Each Army single-use TM has a block for Reporting Errors and Recommending Improvements that provides the address/instructions for reporting changes. Recommended changes are sent to the commodity commands listed below.

8.2.6 Army Points of Contact (POCs).

8.2.6.1 Single POC for Army TM Policy: US Army Publishing Directorate, ATTN: AAHS-PAT, 9301 Chapek Rd., Ft. Belvoir, VA 22060-5527.

8.2.6.2 Single POC for all other publications matters pertaining to equipment publications is Commander, US Army Logistics Support Activity (LOGSA), ATTN: AMXLS-AP (Technical Publications), Bldg 3307, Redstone Arsenal, AL 35898.

NOTE

Requirements for Army publications furnished under FMS Programs are transacted between the US Army Security Assistance Command and the Washington, DC representative of the foreign country.

8.2.6.3 POC for TM Managers responsible for commodity TMs (including issuing, updating, rescinding, MIPR processing, immediate or urgent action change, retrofit instructions):

U.S. Army TACOM LCMC
 ATTN: AMSTA-LCL-IM (M/S 727)
 6501 E. 11 Mile Rd, Warren, MI 48397-5000
 (586) 282-1852
 DSN 786-1852
 Email: usarmy.detroit.tacom.mbx.ilsc-epco@mail.mil

U.S. Army Aviation and Missile Life Cycle Management Command
 ATTN: AMSAM-MSS-LP
 Bldg. 5301, Sparkman Circle, Room 1122
 Redstone Arsenal, AL 35898-5230
 (256) 876-0498
 DSN 746-0498
 Email: usarmy.redstone.amcom.list.immc-pub-epco@mail.mil

U.S. Army Communications and Electronics Life Cycle Management Command
 ATTN: AMSEL-LCI-ECM (Pubs)
 6001 Combat Drive
 Bldg. 6001, Pod C3-322/49
 Aberdeen Proving Ground, MD 21005-1846
 (443) 861-5457/5460
 DSN 848-5457/5460
 Email: usarmy.apg.cecom.mbx.lrc-leo-epco2@mail.mil

TO 00-5-1

U.S. Army TACOM Natick Soldier Systems Center
ATTN: AMSTA-LCS-ECT
Kansas Street
Bldg. 3, Room 120
Natick, MA 01760
(508) 233-6064
DSN 256-6064
Email: usarmy.detroit.tacom.mbx.ilsc-epco@mail.mil (include "TACOM Natick" in subject line)

U.S. Army CECOM Communications Security Logistics Activity
ATTN: SELCL-IA-NMP (EPCO)
2133 Cushing St (Suite 3600)
Fort Huachuca, AZ 85613-7041
(520) 538-8255
DSN 879-8255
Email: csla.huac.epco@mail.mil

U.S. Army Research, Development and Engineering Command (RDECOM), Armament Research, Development and Engineering Center (ARDEC)/Joint Munitions and Lethality (JM&L)
ATTN: RDCB-DEL (APG-ECBC EPCO)
Bldg. 93, 1st Floor
Ramsay Avenue
Picatinny Arsenal, NJ 07806-5424
(973) 724-3247
DSN 880-3247
Email: usarmy.apg.ecbc.mbx.epco@mail.mil

U.S. Army Research, Development and Engineering Command (RDECOM) Edgewood Chemical Biological Center (ECBC)
5183 Blackhawk Road
ATTN: APG-ECBC EPCO
Bldg. E3549/B211 (2nd Floor)
Aberdeen Proving Ground, MD 21010-5224
(410) 436-7245
DSN 584-7245
Email: usarmy.apg.ecbc.mbx.epronencypco@mail.mil

Surface Deployment and Distribution Command (SDDC)
Transportation Engineering Agency (TEA)
1 Soldier Way, Bldg. 1990 West
Scott AFB, IL 62225
(618) 220-5273
DSN 770-5273

8.2.6.4 POCs for Printing, Procurement and Distribution:

U.S. Army Publishing Directorate
ATTN: AAHS-PAR
9301 Chapek Rd., Bldg. 1456
Ft. Belvoir, VA 22060-5527
(703) 693-1549
DSN 223-1549

Media Distribution Division (MDD)
Logistics Management Branch, Customer Service
(314) 592-0900, ext. 0923
DSN 693-7300, ext. 0923
Email: usarmy.stlouis-mo.106-bde.mbx.apdcustsrv@mail.mil

8.3 OBTAINING NAVY PUBLICATIONS.

Navy technical manuals are under the cognizance of several Navy components: Naval Air Systems Command (NAVAIR); Naval Sea Systems Command (NAVSEA); Space and Warfare Systems Command (SPAWAR); Naval Facilities Engineering Command (NAVFAC); and Naval Supply Systems Command (NAVSUP). Other types of Navy publications include departmental directives (instructions) and technical directives (power plant changes/bulletins).

8.3.1 Establishing Subscriptions. Air Force TODOs establish subscriptions and obtain initial issue of current NAVAIR technical manuals (TM) with the Naval Air Technical Data and Engineering Service Command (NATEC). TODOs should submit an Initial Outfitting List (IOL) request IAW NAVAIR 00-25-100 to generate a distribution account with an Automatic Distribution Requirements List (ADRL). Once NATEC receives a tailored IOL from the customer, TMs will be ordered through the Naval Logistics Library (NLL) for current issue and added to the ADRL for subsequent updates. To access your NATEC distribution account and to view or download TMs, including NAVAIR 00-25-100, visit the NATEC web site at <https://mynatec.navair.navy.mil>. TODOs will need to obtain a username and password to access the web site.

8.3.2 Requisitioning TMs. For one-time issue or to replace missing/damaged TMs, submit requisition requests directly to the Naval Logistics Library (NLL). Submit request for username and password at <https://nll2.ahf.nmci.navy.mil/default.cfm> to access the NLL web site. After obtaining a username and password, login and select Navy Publications Index, select P2003 Shopping Cart on the next page and follow procedures.

8.4 OBTAINING MARINE CORPS PUBLICATIONS.

Marine Corp Publications can be located at the Marine Corp Technical Publications site: <https://mceits.usmc.mil/sites/pubs/default.aspx>

8.5 TECHNICAL ORDERS FOR NON-DOD GOVERNMENT ACTIVITIES.

8.5.1 The Air Force Reserve Officers Training Corps (ROTC), Air Force Aero Clubs, and comparable activities will obtain TOs in the same manner as active AF activities. These organizations are subject to the same restrictions on TO distribution and releasability as active duty Air Force organizations. If any TO operations are managed by contractor personnel, the contractor must have a valid DD Form 2345 on file with the AFTO Form 43 establishing the account.

8.5.2 Other U.S. Government agencies are authorized TOs in connection with assigned duties. Reimbursement requirements will be determined by the TO Manager based on stock level and quantity requested.

8.5.3 Releasable TOs (TOs approved for issue by the TO Manager and/or TCM) shall be provided without charge to state, city, and local governments; disaster control and civil defense organizations; and hospitals and schools when the TOs are required to support the operation and maintenance of equipment used in the interest of the general public.

CHAPTER 9

RECOMMENDING CHANGES TO TECHNICAL ORDERS

9.1 GENERAL.

Submit recommendations for TO improvements (including this TO), new maintenance instructions or procedures, correction of errors, or omissions of a technical nature using RCs according to this chapter. Submit one RC per discrepancy since each RC must be evaluated separately. Use AF Form 847 to submit, review, and evaluate RCs to FMP TOs (AFI 11-215). For users of IETMs, changes will be submitted using the associated recommended change function. See MAJCOM Supplement for specific IETM procedures. Joint Nuclear Weapons Publication System (JNWPS) technical order recommended changes must be submitted IAW JNWPS TO 11N-5-1, *Unsatisfactory Reports*.

9.1.1 TO Updates. Official TO updates are the only valid authority for correcting a technical deficiency and implementing approved RCs. Replies to RCs are for information only. Do not use approved RCs to perform operations and maintenance in lieu of published TO procedures. See **EXCEPTION**, paragraph 2.17.4.1.

9.1.2 Technical Assistance. Request technical assistance according to TO 00-25-107 or TO 00-25-108 for TO problems that meet the exceptions of paragraph 1.4.11 and for work stoppages.

9.1.3 New TO Types. Submit proposals for new types of TOs (not covered by existing MILSPECs) to the Air Force Preparing Activity (PA) Helpdesk contact: sgmlsupport@us.af.mil (TMSS), AFLCMC/HIAM, for review and disposition. This does not apply to COTS manuals purchased under acquisition reform guidelines and included in the TO system. See TO 00-5-3 for additional details.

9.1.4 Flight Manuals Program Publications. Submit RCs to FMP publications according to AFI 11-215.

9.1.5 Work Unit Code (WUC) Manuals. Recommendations on WUC (-06) Manuals requesting new code assignments will normally be limited to repairable items. Codes may be requested for non-repairable items with proper justification.

9.1.6 Deficiency Reports. Submit hardware problems and software deficiencies in accordance with TO 00-35D-54, *USAF Deficiency Reporting and Investigating System*, but not as RCs under this TO.

9.1.7 Calibration Responsibility Determinations (AFTO Form 45, Request for Calibration Responsibility Determination). Organizations requiring such determinations will submit recommendations in accordance with TO 00-20-14.

9.1.8 Acquisition and PTOs. TO 00-5-3 covers the additional methods and special routing of RCs on TOs (including FMP TOs) and PTOs during acquisition.

9.1.9 Support Equipment Requirements. Submit RCs to update the equipment requirements in support and test equipment tables **ONLY** when substitutions are not authorized in the table or elsewhere in the TO.

9.1.10 Contractor Data. Submit discrepancies discovered in contractor data by letter through the MAJCOM headquarters to the PM or SCM. After review, the PM/SCM will forward letters to the contractor. The letter should identify the contractor data that is in error, equipment it supports, proposed fix (if known), submitting organization, individual who discovered the error, and a phone number where the submitter can be contacted. There is no structured reply system for these recommendations due to the unique nature of each Contractor Logistics Support/Contractor Support (CLS/CS) contract.

9.1.11 Classified Recommendations. Mark, transmit, and handle classified RCs in accordance with DoDM 5200.01 Vol 1-4/AFI 16-1404. Mark RCs containing classified data with the security classification of the page for which the recommendation is being submitted. Enter classification authority and downgrading instructions in Block 19 of the AFTO Form 22. Identify unclassified recommendations on classified TOs as such. RCs on limited distribution TOs will contain the same distribution code as the TO, and be submitted attached to signed and encrypted SMTP e-mail. Report security violations involving TOs according to DoDM 5200.01 Vol 1-4 and AFI 16-1404.

TO 00-5-1

9.1.12 Airmen Powered by Innovation Program (API). The IDEA program has been renamed to the Airmen Powered by Innovation (API) program. AFI 38-402, *Airmen Powered by Innovation*, formalizes and provides guidance for the API program. This guidance outlines the procedures for submitting, evaluating, and implementing ideas as well as tracking and confirming results benefits. Website reference at <https://ipds.afpc.randolph.af.mil>.

9.1.13 Using AFTO Form 22 to Process Recommended Changes. Submit an AFTO Forms 22 via e-mail attachment through coordination channels to the TO Manager. Ensure forms containing restricted distribution data are sent using the CAC or ECA certificate to digitally sign and encrypt the e-mail message. See paragraph 9.7.1 for instructions on downloading the form and the AFTO Form 22 itself for completion instructions.

9.1.13.1 The AFTO Form 22 is authorized for industry use by Office of Management and Budget number 0704-0188 (Data Item Description DI-TMSS-80229, Technical Order Improvement Report and Reply). The AFTO Form 22 is not used to submit source data or contractor-developed update packages.

9.1.13.2 The AFTO Form 22 is authorized for submitting changes to Communications Security maintenance publications produced by the National Security Agency and the Air Force. Procedures for the use of the AFTO Form 22 for these specialized publications are included in AFKAG-1N, (FOUO) Air Force Communications Security Operations. Direct questions on this policy to AFSPC CYSS/DOO, 203 W. Losey St, Rm 2200, Scott AFB IL 62225-5222, cyss.doo@us.af.mil.

9.1.14 Mishap Investigation Directed Changes. For safety mishap investigation change requests, provide the local control number (LCN) to the safety investigator for inclusion in the mishap report recommendation.

9.1.15 Submitting Changes to Joint-Use TMs. AF policy requires approval of the assigned AF manager prior to submittal to the responsible service TM manager. Therefore, all recommended changes (AFTO Forms 22) will be submitted on joint-use technical manuals using the assigned Air Force TO number, to the appropriate Air Force TO Manager (listed in the ETIMS TO Catalog) for resolution. Proposed updates to non-TO-numbered Army manuals will be submitted according to DA Pamphlet 25-33, User's Guide for Army Publications and Forms (<http://www.apd.army.mil/>). Proposed updates to non-TO-numbered NAVAIR manuals will be submitted according to NAVAIR 00-25-100, *NAVAIR Technical Manual Program*. For procedures on updating other Navy, Marine Corps or DLA non-TO-numbered manuals, contact the TM OPR directly.

9.1.16 Updates to 00 Series TOs. Updates to technical orders 00-5-1, 00-5-3, and 00-5-15 shall be approved by HQ AFMC/ A4FI after Air Force Centralized Technical Order Management (CTOM) committee consideration. Updates to any other 00 series TOs are approved by the TCM and Chief Engineer assigned to the subject matter of the applicable TO.

9.1.17 Source, Maintenance, and Recoverability (SMR) Code Changes. Use an RC to request a new SMR code where none was previously assigned.

9.2 SUBMITTING RECOMMENDED CHANGES.

Submit an RC against a single discrepancy, except as noted in paragraph 9.2.3. Check the "AFTO 22 Routing Procedures" file on the "Tech Order Recommended Change Processing" AFNET, accessible at <https://cs3.eis.af.mil/sites/OO-TO-00-59/default.aspx> to determine if MAJCOM unique, special routing or information copy procedures apply. If not, the routing of routine and urgent RCs (paragraph 9.6) is initiator and initiator supervisor with submission by the PIM. The PIM then forwards the AFTO Form 22, in turn, for review (paragraph 9.3) and on to the TO manager for subsequent evaluation (paragraph 9.4). The routing of emergency RCs (paragraph 9.6) is initiator and initiator supervisor with submission by the PIM directly to the TCM for evaluation, with copies to the Major/Lead CCPs and the TO Manager. When submitting RCs, identify the TO (publication number, basic date, change number and change date) and the item within the TO (paragraph, figure, table or task identifier) requiring improvement or correction. The RC change type (paragraph 9.2.1) and the recommendation priority (paragraph 9.6) must also be entered. When submitting an AFTO Form 22, the initiator attaches all necessary supporting documents. Submitters will comply with applicable special coordination and information copy procedures (paragraph 9.8).

9.2.1 An RC must be identified as an "improvement" or "correction" type of change. An "Improvement" will result in an addition or significant change to a process or procedure which allows a function to be performed better, safer, faster or cheaper. A "Correction" merely fixes a minor error or omission in the TO, such as:

- Merely calling attention to a word omission or typographical or printing errors that would normally be corrected during scheduled reviews and do not cause misinterpretation;
- Illustration errors that do not detract from the performance of a procedure;

- Updates to correct or add new names/numbers of a referenced Air Force publication, specification or standard, unless the reference change affects or could affect the assurance and preservation of the OSS&E attributes of the covered system or equipment;
- Identifying other non-technical errors in a TO, and/or
- Recommending minor word changes or corrections to technical data that clarify or expand existing instructions, but are not essential for the adequate performance of the functions required for mission accomplishment, unless the initiator specifically describes the problems that will be prevented and/or gives examples of prior problems.

9.2.2 Foreign users of Air Force TOs submits an AFTO Form 22 through the SAP/FMS TODO IAW TO 00-5-19. The TODO ensures inputs have been prepared properly and legibly and provides the TODO identification in Block 1.

9.2.3 Since each recommendation must be evaluated individually, submit against a single discrepancy. Exceptions for AFTO Form 22 are as follows:

9.2.3.1 When the same change must be made in multiple TOs managed by the same PM or SCM, one form will be written against one of the TOs, and the other TO numbers will be listed with the affected page and paragraph numbers in Block 19. (See paragraph 9.2.4 for AFTO Form 22 procedures when TOs are managed at different PMs/SCMs).

9.2.3.2 If the same error occurs more than once in a TO, all locations will be identified on the same AFTO Form 22.

9.2.3.3 Changes submitted against inspection (-6) TOs will identify all locations where the changes are needed, including associated workcards (-6WC), and vice versa, whenever possible.

9.2.3.4 Forms submitted on calibration TOs (Category 33K) will identify all related corrections in any calibration TO.

9.2.3.5 Recommended changes submitted on a single TO procedure will include all known related changes to that procedure.

9.2.3.6 Minor corrections which do not affect the performance of tasks or the OSS&E attributes of the covered item may be held until other updates to the affected page or its backing page are required. If the change could or would affect OSS&E attributes, the change will be made in the next routine TO update.

9.2.3.7 Contractors must route RCs thru the lead command CCP, unless specifically exempted.

9.2.4 When a recommended change affects more than one TO and the TOs are managed at different PMs or SCMs, and approval or disapproval actions between TOs must be consistent, the submitter will initiate an RC for each affected TO. Use the local control numbers to cross-reference each recommendation to all others submitted for the same problem.

9.3 REVIEWING RECOMMENDED CHANGES.

Reviewers begin by checking the RC (including attachments) for validity, accuracy and completeness. Consult with submitters, as needed, to correct the RC. When appropriate, the reviewer changes the RC type, RC priority and idea value. Ensure supporting documentation for improvement RCs is thorough, accurate and from an official source (e.g., REMIS, IMDS, etc.). Additionally, ensure man-hour savings are verified. If disapproved by any reviewer, the RC is returned to the submitter. Prior to routing, check the "AFTO 22 Routing Procedures" file on the "Tech Order Recommended Change Processing" AFNET, accessible at <https://cs3.eis.af.mil/sites/OO-TO-00-59/default.aspx> to determine if MAJCOM unique, special routing or information copy procedures apply. If not, the MAJCOM CCP reviewer returns the approved AFTO Form 22 to the PIM so the review date can be entered before forwarding to the Lead CCP reviewer. Similarly, the lead CCP reviewer returns the approved AFTO Form 22 to the PIM so the review date can be entered before forwarding to the TO manager and subsequent evaluation. Timelines for PIM follow-up actions are outlined in paragraph 9.5 while timelines for evaluator disposition and action based upon RC priority are outlined in paragraph 9.6.

9.4 EVALUATING RECOMMENDED CHANGES.

9.4.1 **General.** The TCM first reviews the RC and supporting documentation for validity, accuracy and completeness. The TCM then assigns the appropriate disposition (paragraph 9.4.2) and provides required remarks (paragraph 9.4.3). Once dispositioned, the ES notifies the submitter and the TO manager. AFTO Form 22 evaluators are responsible for providing interim and final disposition to the initiator, PIM, and other activities using the electronic AFTO Form 22 (paragraph 9.7). Approved RCs will be implemented as TO updates (Chapter 2) by the method and within the time prescribed by its recommendation priority (paragraph 9.6). TCMs will review approved routine RCs every 90 days until incorporated, for possible recommendation priority upgrade and expedited publication.

TO 00-5-1

9.4.2 Disposition Definitions.

9.4.2.1 Approved. The intent of the recommendation will be included in the TO within 365 calendar days.

9.4.2.2 Deferred. The recommendation is approved but limiting factors prevent publication within 365 calendar days, OR the changes are minor and will be incorporated when the affected pages are updated for other reasons. Provide the resolution date for the limiting factors and reasons for the delay as a disposition remark. Deferred status items will be published when limiting factors no longer exist. Minor changes will be incorporated if the applicable page(s) of the TO are updated for other reasons, such as a modification, new acquisitions etc., or at the next TO revision.

9.4.2.3 Abeyance. Evaluation delayed for management reasons. Used for routine recommendations when existing factors preclude processing RC within the normal processing time frame. These factors include recommendations affecting TOs on obsolete systems and equipment or TOs controlled by all-MAJCOM committees such as the Air Force CTOM. Recommendations from foreign countries under the SAP will not be placed in abeyance. Provide the specific reason and expected resolution as a disposition remark.

9.4.2.4 Advisement. Engineering study is required before evaluation can be completed. Evaluation time will extend beyond normal time limits. Provide the expected resolution date as a disposition remark.

9.4.2.5 Duplicate. Use when an RC identifying the same deficiency and proposing the same solution was submitted earlier, whether approved or disapproved, and no matter the source of the previous submittal. Enter the previous RC's local control number as a disposition remark. If the two RCs were received within the same time frame, but proposed different solutions, the RCs are not considered duplicates and each must be evaluated on its own merits. Approve the RC providing the solution that best corrected the deficiency, and provide rationale for the decision on both the approved and disapproved RCs. If the first RC has already been approved and implemented, evaluate the second RC on its merits, and if necessary, approve it and re-modify the solution. Duplicate status shall **NOT** be used when the current recommendation is a rebuttal of a previous disapproval.

9.4.2.6 Disapproved. The reason for disapproval will be explained in disposition remarks.

9.4.2.7 Other. Mark this block when one of the status codes listed in paragraph 9.7.1 applies.

9.4.3 Disposition Remarks. Provide remarks against all RC dispositions except for Abeyance or Approval as written, which require no comments. Provide the justification for downgrading the report urgency or changing the Type of Change (Block 7) or expected dollar/manpower savings associated with the RC. Include reasons for any modifications to the recommended change wording and for considering this report a "Duplicate" (if applicable). On approved and deferred Improvement-type forms, include justification for recommended idea benefits, whether Tangible or Intangible (Block 28), or for changing the calculations for the amount of tangible benefits. This is not required on Correction-type forms.

9.4.3.1 Units who wish to appeal the disposition of their AFTO Form 22 will refer to their applicable MAJCOM supplements.

9.5 FOLLOWING-UP RECOMMENDED CHANGES.

9.5.1 Follow-up will normally be initiated by the PIM.

9.5.2 For emergency RCs, PIM may follow-up with the evaluator within 48 hours of submission. For urgent and routine RCs, PIMs may follow-up within 14 calendar days of submission to the MAJCOM or Lead Command reviewers and within 45 calendar days of submission to the evaluator.

9.5.3 When disapproval of an RC, change to the RC type (paragraph 9.2.1) or priority (paragraph 9.6) is considered unacceptable, the initiator may submit it for reconsideration. The initiator resubmits using a new local control number, referencing the previously assigned control number and giving rationale for the resubmission.

9.6 RECOMMENDATION PRIORITIES.

The initiator must also determine the recommendation priority when creating the RC on the AFTO Form 22. The recommendation priority is based upon the likelihood that adverse consequences will occur and degree of adverse impact if the change is not implemented within a given timeline. The recommendation priority determines the RC transmission method, RC routing and the timeline for implementing, downgrading or disapproving the RC. These variables are pre-

programmed into workflow management while Product Improvement Managers are responsible for appropriately transmitting RCs submitted on an AFTO Form 22.

9.6.1 Emergency. Emergency recommendations require immediate action on a TO deficiency which, if not corrected, **WOULD** result in a fatality or serious injury to personnel, extensive damage or destruction of equipment or property, or inability to achieve or maintain operational posture (MISSION ESSENTIAL), including field-level work stoppage. In addition, emergency includes discrepancies that directly affects the handling, maintenance, operations, transportation, training, and testing or storage of nuclear weapons.

9.6.1.1 Emergency recommendations will be submitted or transmitted as a “High” precedence SMTP e-mail directly to the organization having management responsibility for the TO with an information copy to the designated CCPs. The responsible TO management organization and CCP addresses, as well as special coordination and information copy addresses, are listed in the “AFTO Form 22 Routing Procedures” file on the “Tech Order Recommended Change Processing” AFNET, accessible at <https://cs3.eis.af.mil/sites/OO-TO-00-59/default.aspx>. Use the same e-mail message precedence for the information addressees only if all addressees require the message with the same urgency. The e-mail message subject will be “EMERGENCY AFTO Form 22.” Attach a copy of the AFTO Form 22. A read receipt on the e-mail message is required. Initiators must notify the TO Manager of the Emergency submittal by telephone or e-mail.

9.6.1.2 An emergency recommendation requires the TCM, in coordination with the TO management office, to either issue an ITCTO (TO 00-5-15), RAC (paragraph 2.16.3) or interim supplement (paragraph 2.17.4.1) within 48 hours (72 hours for work stoppage) after receipt, or requires the TCM to disapprove or downgrade the recommendation within the same time frame. Emergency recommendations can only be downgraded with the concurrence of the Lead Command CCP.

9.6.2 Urgent. Urgent recommendations require action on a TO deficiency which, if not corrected, **COULD** cause one or more of the following: personnel injury; damage to equipment or property; reduce operational efficiency, and/or jeopardize the safety or success of mission accomplishment. Submit RCs that could result in over \$25,000 or 1000 man-hours annual savings to the Air Force as urgent. All technical TCTO deficiencies are submitted as urgent. Identification of or replacements for EPA Hazardous Materials (HAZMAT) and ODS are submitted as urgent. In addition, urgent includes all other discrepancies that indirectly affect a nuclear weapon and technical orders that indirectly affect the handling, maintenance, operations, transportation, training, and testing or storage of nuclear weapons.

9.6.2.1 Urgent recommendations will be submitted or transmitted as a “Normal” precedence SMTP e-mail. The responsible CCP and TO management organization addresses, as well as special coordination and information copy addresses, are listed in the “AFTO Form 22 Routing Procedures” file on the “Tech Order Recommended Change Processing” AFNET, accessible at <https://cs3.eis.af.mil/sites/OO-TO-00-59/default.aspx>.

9.6.2.2 An urgent recommendation requires the TCM, in coordination with the TO management office, to publish and distribute a TO update within 40 calendar days after receipt of the recommended change by the TO management office (using activities must allow for mail and TODO redistribution time), or disapprove/downgrade the recommendation within fifteen calendar days. Urgent recommendations can only be downgraded with the concurrence of the Lead Command CCP.

9.6.3 Routine. Routine recommendations require action on TO deficiencies that do not fall into emergency or urgent categories.

9.6.3.1 Routine recommendations will be submitted or transmitted as a “Normal” precedence SMTP e-mail. The responsible CCP and TO management organization addresses, as well as special coordination and information copy addresses, are listed in the “AFTO 22 Form Routing Procedures” file on the “Tech Order Recommended Change Processing” AFNET, accessible at <https://cs3.eis.af.mil/sites/OO-TO-00-59/default.aspx>.

9.6.3.2 A routine recommendation requires the TCM to respond within 45 calendar days after receipt at the ALC. Routine recommendations should normally be published and distributed in a TO update within 365 days after receipt of the recommended change. If the RC was submitted using an AFTO Form 22, copies of the response will normally be sent to the initiator and activities in Blocks 1, 2 and 3 using the AFTO Form 22. Routine recommendations may be returned provided it addresses all of the pertinent elements of the submitted AFTO Form 22, including any API program elements.

9.6.3.3 TCMs will review approved and deferred routine RCs every 90 days following the disposition date to determine if the RC priority should be upgraded because of accumulated RCs, engineering changes to the system, mishap findings, etc. The TCM will coordinate the proposed RC priority upgrade with the TO Manager and the Lead Command CCP and, if approved, publish and distribute a TO update by the methods and within the timelines associated with the upgraded priority.

9.7 AFTO FORM 22 PROCEDURES.

9.7.1 General. The AFTO Form 22 must be completed digitally using the latest version of the IBM Lotus form. A Word version of the form should be made available to contractor initiators who are unable to run the Lotus Viewer software on their computer networks. An AFTO Form 22 should then be submitted as an e-mail attachment. Unless the TO in question is STINFO code “A - For Public Release,” the e-mail must be digitally signed and encrypted. Parties without CAC capability may obtain external certificate authority (ECA) certification to allow signing and encrypting e-mail. Copies may also be submitted on digital media sent via an approved mail carrier (e.g., the U.S. Postal Service). Paper copies will not be accepted without prior coordination and approval of the TO Manager.

9.7.2 Providing Status Information. Evaluators shall e-mail updated AFTO Form 22 copies to organizations specified in paragraph 9.4.1 and paragraph 9.6, Recommendation Categories, any time the RC status changes.

9.8 RECOMMENDED CHANGES AND THE AIRMEN POWERED BY INNOVATION (API) PROGRAM.

The IDEA program has been renamed to the Airmen Powered by Innovation (API) program. AFI 38-402 formalizes and provides guidance for the API program. This guidance outlines the procedures for submitting, evaluating, and implementing ideas as well as tracking and confirming results benefits. Website reference at <https://ipds.afpc.randolph.af.mil>.

9.8.1 Submissions to make TO changes are not accepted in the API Program. However, after an “improvement-type” TO change has been adopted and implemented in the TO, the Approved AFTO Form 22, along with the excerpt from the published/updated TO, can be considered for the API program.

Table 9-1. AFTO Form 22 Detailed Completion Instructions

Block	Instructions
<p>GENERAL Signatures</p> <p>Addresses</p>	<p>Initiators should retain a printed, signed and dated copy of the form for record and API program purposes. While digital signatures on the IBM Lotus version of the AFTO Form 22 are preferred, handwritten signatures are also acceptable. Signatures are NOT required in order to evaluate an e-mailed AFTO Form 22 before submittal as the e-mail address record is sufficient proof of identity. Forms without digital signatures will be accompanied by a printed and signed AFTO Form 22.</p> <p>Enter complete mailing addresses with 9-digit ZIP codes. Enter either organizational or individual e-mail addresses.</p>
<p>INITIATOR PROCEDURES Block 1, FROM PIM (or Equivalent)</p>	<p>Product Improvement Manager (PIM) or equivalent reviewing/approving activity. Contractors will enter the Quality Assurance or equivalent function in Block 1.</p>
<p>Block 2, MAJCOM CCP</p>	<p>As identified in the routing information accessible at https://cs3.eis.af.mil/sites/OO-TO-00-59/default.aspx. If not identified, leave blank. If the initiating command is also the lead command, leave blank. For contractors, when contract schedules or costs are affected, enter the ACO/PCO and send an information copy to the Using Command CCP (if identified).</p>
<p>Block 3, Lead Command CCP</p>	<p>As identified in the routing information accessible at https://cs3.eis.af.mil/sites/OO-TO-00-59/default.aspx. All contractor reports must be routed through the assigned Lead Command unless specifically exempted.</p>

Table 9-1. AFTO Form 22 Detailed Completion Instructions - Continued

Block	Instructions
Block 4, TO Management Activity	TO management office shown in the ETIMS TO Catalog (as “Proponent ID”) unless special routing applies. See routing information, accessible at: https://cs3.eis.af.mil/sites/OO-TO-00-59/default.aspx
Block 5, LOCAL CONTROL NUMBER (LCN)	See “Local Control Numbers Assignment Convention” file available at https://cs3.eis.af.mil/sites/OO-TO-00-59/default.aspx .
Block 6, PRIORITY	Check the appropriate box, Emergency, Urgent or Routine (paragraph 9.6 and subs).
Block 7, CHANGE TYPE	Check either CORRECTION or IMPROVEMENT based on the nature of the recommendation being submitted (paragraph 9.2.1). Subsequent reviewers and evaluators will verify this entry and change it if justified. The reason for changing the type will be documented in Block 26, Disposition/Remarks.
Block 8, INITIATOR	Block is self-explanatory, however if the initiator would like notification of the AFTO Form 22 disposition in the event they are deploying or may be changing assignments, put in e-mail for life address (e.g., jane.doe@us.af.mil).
Block 10, PUBLICATION NUMBER	Enter the complete TO or supplement number as it appears on the title page. Include parentheses and dashes between numbers. Use capital letters.
Block 11, BASIC DATE	Enter the TO basic date (lower left-hand corner of the title page).
Blocks 12 and 13, CHANGE NO. CHANGE DATE	Enter the latest TO change number and TO change date, not the change number (if any) on the page containing the deficiency.
Block 14, WORK PACKAGE/WORK CARD ID	For work package TO recommendations, identify the work package number. For work cards, enter the routine and card number instead of a page number.
Blocks 15 through 17, PAGE NUMBER, PARAGRAPH NUMBER	For Block 15, enter only the first page if multiple pages are affected, and explain in Block 19. For Block 16, enter System/Subsystem/Subject Numbers (S/S/SN) for manuals using this system. For Block 17, enter “Table” before the number when applicable. For Interactive Electronic Technical Manuals, enter the task number in Block 15 (preceded by “Task”) and enter step ID in Block 16 (preceded by “Step”) if page number does not exist.
Block 18, SHORT DESCRIPTION OF DEFICIENCY	Enter a brief (up to 200 alphanumeric characters) description of the deficiency.
Block 19, DEFICIENCY	Identify the military system when this is not included in the TO number. If not a system, identify end items by MDS or TMS and National Stock Number or part number. Omit for general and MPTOs. Enter a complete description of the TO deficiency or enhancement, and justification for the recommendation. When appropriate, indicate or attach the source documents for changes in voltage, part numbers and so forth.
Block 20. RECOMMENDED TM CHANGE	Word the recommended change as closely as possible to the exact language which should appear in the corrected TO. If the wording is not known, that is, the correction will require engineering research or extensive verification, specify the type of correction (for example, “Add more in-depth fault isolation procedures.”) and/or state “Unable to develop at field level.” Attach additional files if needed, showing the local control number in the upper right hand corner of each sheet.

Table 9-1. AFTO Form 22 Detailed Completion Instructions - Continued

Block	Instructions
<p>Block 20. RECOMMENDED TM CHANGE (Cont)</p>	<p>If the initiator believes implementation would result in tangible savings, attach an estimate of the amount of the savings with justification to the AFTO Form 22, along with any backup material. (Paper backup material can either be scanned into an electronic file, or be described in the AFTO Form 22 and provided upon request via post mail.) Reviewers and evaluators at all levels must review this estimate and add concurrence or revised values as appropriate. The initiator must provide a brief description of expected intangible benefits for AFTO Form 22 recommendations without tangible benefits.</p>
<p>Blocks 21 and 22, SAVINGS/YR - DOLLARS & MANHOURS</p>	<p>The initiator will enter the estimated annual saving in dollars and manhours resulting from the TO change recommendation, or leave the blocks blank if no savings are anticipated. Each subsequent reviewer/evaluator is authorized to change these two blocks.</p>
<p>Block 27, IDEA BENEFITS</p>	<p>If the RC is an "Improvement" type, the initiator will complete Block 27 according to AFI 38-402. Indicate whether the idea benefits would be "Tangible" or "Intangible" or both (If reduced manhours do not reduce manning requirements, the benefits are intangible). For tangible savings, enter the value here.</p>
<p>INITIATOR'S SUPERVISOR PROCEDURES Block 9, INITIATOR'S SUPERVISOR</p>	<p>The supervisor of the initiator or, for flight crew members, the responsible Stan-Eval officer will enter their name, rank, DSN and e-mail address in this block. For all TOs and technical data applicable to weapons/munitions loading, the Weapons Standardization Section Superintendent, Loading Standardization Crew (LSC) or Wing Weapons Manager will complete this block. When the initiator is the MAJCOM reviewing authority, enter N/A and complete Block 2 (Approved/Disapproved). The individual identified in Block 9, after ensuring the recommendation is valid and warrants submittal, forwards the AFTO Form 22 to the organization identified in Block 1.</p>
<p>Blocks 1-3, PIM, MAJCOM CCP and Lead Command CCP "Approval" or "Disapproval"</p>	<p>Enter reviewer names and DSN numbers in the allotted boxes, and check either Approved or CCP and Lead Command Disapproved in the appropriate address blocks. Return approved and disapproved forms through the CCP Approval or coordination channel to the submitter (Block 8).</p> <p>Comments by the PIM or CCPs shall be identified as such and included in Block 19 or in the "Continuation" block. When the CCP deems that expeditious processing with rationale may be entered. PIM or MAJCOM reviewers who disapprove of an AFTO Form 22 for any reason will document the action and reasons in the Continuation block (Block 26).</p> <p>If reviewers and evaluators disagree with initiator recommendations for the "Savings" (Blocks 21 and 22) or the "Intangible" vs "Tangible" idea benefits, provide revised recommendations and justification in the continuation block or an attachment to the form. The justification must include why tangible benefits could not be assigned, and what areas will be affected by the intangible benefits (safety, security, work flow, etc.)</p>

Table 9-1. AFTO Form 22 Detailed Completion Instructions - Continued

Block	Instructions
EVALUATOR PROCEDURES	<p>Upon receipt of an approved AFTO Form 22 from the MAJCOM CCP, the PIM will review any changes, enter the review date in Block 28 and forward the form to the Lead Command CCP. PIMs will follow up if RC is not returned within 14 calendar days of submission. Upon receipt of an approved AFTO Form 22 from the Lead CCP, the PIM will review any changes, enter the review date in Block 28 and forward the form to the TO Management Activity. Follow up with the evaluator if a disposition is not received within 48 hours for an emergency RC or 45 days for an urgent or routine RC. (paragraph 9.4 and subs).</p> <p>The evaluator is technically responsible for the contents of the TO (the Technical Content Manager, TCM). The evaluator will determine if the recommended change type is a correction or improvement and the submitted data is correct. AFTO Form 22s and any back up material must be retained by the TCM (see paragraph 5.10.5) after disapproval or update incorporation, according to AFI 33-364, <i>Records Disposition - Procedures and Responsibilities</i>, and the RDS at https://www.my.af.mil/gcss-af61a/afirms/afirms/rims.cfm.</p> <p>Reports received by evaluators (Block 4) without having been routed through MAJCOM CCP (Block 2) and Lead Command CCP (Block 3 - unless exempted by the Lead Command) will be returned to the reporting organization without action. A statement to this effect will be entered in Block 19 of each report returned without action.</p>
Block 23, EVALUATOR	(Self explanatory)
Block 24, EVALUATORS SUPERVISOR	<p>The first-level supervisor of the individual in Block 23 will enter their name, office symbol and DSN in this block for APPROVED, DUPLICATE, or initial 60-day ADVISEMENT actions. This authority may be delegated to the TCM for the applicable TO. If delegated, so state in the continuation block along with the supervisor's name and e-mail address. If the initial AdviseMENT period is known to require more than 60 calendar days, the second-level supervisor may approve a period of up to six months, with any subsequent extensions approved at the same level. All other actions will be approved by no lower than the first-level supervisor with progressively higher approval levels (not to exceed division) for any subsequent rebuttals or extensions.</p>
Block 25, DISPOSITION	Check the appropriate action taken.
Block 26, DISPOSITION/REMARKS	<p>Provide remarks against all RC dispositions except for Abeyance or Approval as written, which require no comments (paragraph 9.4). The TCM/ES/Engineer will mark the appropriate "Verification" blocks if the changed procedure requires verification (see TO 00-5-3).</p>
Block 27, IDEA BENEFITS	<p>Evaluators will review and validate whether the proposed improvement will yield tangible or intangible savings. Evaluators will briefly document their review in Block 28.</p>

CHAPTER 10

NUCLEAR WEAPON CENTER (NWC), NUCLEAR RELATED EXPLOSIVE ORDNANCE DISPOSAL (EOD) AND NONNUCLEAR EOD TECHNICAL ORDER MANAGEMENT

10.1 INTRODUCTION.

This chapter outlines procedures for obtaining, managing, and distributing nuclear weapons center and nuclear related EOD TOs indexed in TO 0-1-11N and TO 0-1-11N-1-CD-1, and nonnuclear EOD TOs indexed in the Automated EOD Publications System (AEODPS). TOs managed in the 11N Indexes require special handling and will meet the requirements in AFNWC Supplement to AFI 16-1404 as a condition of use.

10.1.1 Nuclear Weapon and Nuclear Related EOD TOs. The 708th Nuclear Sustainment Squadron (NSUS) manages all Category 60N and Category 11N TOs, as referenced in TO 0-1-11N and TO 0-1-11N-1-CD-1. In addition, AFNWC/ NDE is the focal point for managing Category 1 load, air transport and delivery TOs, and air-launched missile warhead mate/demate TOs listed in TO 0-1-11N-1-CD-1, with individuals assigned as TCMs. AFNWC/ NDE manages and maintains nuclear weapon and nuclear related TODO accounts, publishes the TO 0-1-11N-1-CD-1 index, and distributes the Joint Nuclear Weapons Publication System (JNWPS) data via paper, CD, CD TO or Defense Integration and Management of Nuclear Data Services (DIAMONDS). The TO management agency indicated in the distribution statement on the TO title page, or listed in the TO 0-1-11N-1-CD-1 index, responds to questions about TO content or improvement reports.

10.1.2 Intercontinental Ballistic Missile (ICBM) TOs. AFNWC/NIEV manages all ICBM TOs indexed in TO 0-1-11N-1-CD-1, with individuals assigned as TCMs.

10.1.3 Nonnuclear EOD TOs. Category 60 EOD TOs are joint service technical manuals, which inform and guide EOD personnel, but do not address specific incidents/situations. EOD personnel rely upon their training and expertise to render safe and/or dispose of explosive ordnance and do not require waivers to deviate from EOD TO procedures.

10.1.3.1 The Department of the Navy is Executive Manager of the joint service EOD program under DODD 5160.62, Single Manager Responsibility for Military Explosive Ordnance Disposal Technology and Training (EODT&T). The Naval Surface Warfare Center Indian Head Explosive Ordnance Disposal Technology Division (NSWC IHEODTD), Indian Head MD, prepares, numbers, and distributes nonnuclear EOD publications in accordance with individual service requirements.

10.1.3.2 The Air Force Civil Engineer Center, EOD Joint Service Acquisition, Sustainment and Technology Division (AFCEC/CXE) is the Air Force liaison to the NSWC IHEODTD. AFCEC/CXE provides management oversight, assists with joint service verification of nonnuclear EOD TOs and determines usability of these TOs for the Air Force.

10.2 CONTACT POINTS.

10.2.1 Nuclear Weapons Center and Nuclear Related EOD TOs. Contact AFNWC/ NDET, 2000 Wyoming Blvd SE, Kirtland AFB, NM 87117-5617, e-mail: AFNWC.NCL@us.af.mil, phone: DSN 263-3610 or commercial (505) 853-6310, fax: DSN 246-8911 or commercial (505) 846-8911 concerning management policies, procedures, requirements, requisitions, assignment and cancellation of NW/ICBM TODO accounts, and assignment of new TO numbers. Contact the appropriate TO management agency indicated in the distribution statement on the TO title page, or listed in the TO 0-1-11N-1-CD-1 index concerning TO content or improvement reports.

10.2.2 Nonnuclear EOD TOs and Data. Contact AFCEC/CXE, 2008 Stump Neck Road, Indian Head MD 20640-3681, e-mail: afcec_cxe@navy.mil, phone: DSN 354-6824 or commercial (301) 744-6824, fax: DSN 354-4027, concerning management policies, procedures, requirements, requisitions, assignment and cancellation of nonnuclear EOD TODO accounts, TO content, or improvement reports.

10.3 PROCEDURAL GUIDANCE.

10.3.1 When a task is performed on a nuclear or conventional weapon delivery system and it is not practical for personnel to have physical access to TOs, a verbal demand-response technique must be used. The step to be performed, along with all

TO 00-5-1

notes, cautions and warnings, will be read to the technicians performing the work. The performing technicians will acknowledge understanding, perform the step, and then verify completion. If the environment (noise, weather, etc.) does not allow a verbal demand response, the MAJCOM can authorize an alternate form of communication. Aircraft weapons loading tasks will execute demand-response through weapons loading checklist and the Weapons Load Training certification program.

10.3.2 Interim Changes (IC) issued in support of JNWPS manuals are filed in the same manner as interim operational supplements and operational supplements.

10.3.3 Nuclear Related EOD TODO accounts authorized Category 60N TOs are approved to order other applicable nuclear weapon TOs. Nonnuclear EOD TODO accounts are only authorized to order nuclear related EOD TOs when approved by the MAJCOM EOD functional manager.

10.3.4 United States organizations monitoring loading of special weapons on non-U.S. aircraft may identify/mark steps impacting nuclear surety as determined by the AFNWC/ OLRAM/WS3, AFNWC/NDEO Engineering Liaison Office (ELO). U.S. load monitor checklists containing markings will only be used to verify nuclear surety and will not be used to perform actual loading operations.

10.4 TECHNICAL ORDER INDEXES.

10.4.1 Nuclear Weapons ICBM and Nuclear Related EOD TO Indexes. TO 0-1-11N, Numerical Index to Joint Nuclear Weapons Publications, lists all joint-use technical publications and video applicable to the Joint Nuclear Weapons Publication System (JNWPS). TO 0-1-11N-1-CD-1, Numerical Index to Joint Nuclear Weapons Publications – AF Supplement lists all nuclear and ICBM TOs used exclusively by the Air Force. The managing agency for each TO is listed in this index.

10.4.2 Nonnuclear EOD TO Index. The Joint EOD Mobile Field Kit (JEOD MFK) software contains a complete index of all nonnuclear EOD TOs within the AEODPS. These TOs are indexed in the JEOD MFK software “search” function.

10.5 NUCLEAR WEAPON ICBM AND NUCLEAR RELATED EOD TECHNICAL ORDER DISTRIBUTION REQUIREMENTS.

10.5.1 Establishing Nuclear Weapons Center and Nuclear Related EOD Technical Order Accounts (AFTO Form 43). The AFTO Form 43 will be used to request assignment, change, or cancellation of nuclear weapon ICBM and nuclear related EOD TODO accounts. The AFTO Form 43 will be completed in accordance with Chapter 4. The requesting office will forward the completed signed form to their respective MAJCOM (Table 10-1), or supporting Air Force Installation and Mission Support Center (AFIMSC) Detachment (Table 10-1), or contracting officer for review/approval. After MAJCOM/Contracting Officer approval, this form will be forwarded to AFNWC/ NDET for final approval. Transmittal of the AFTO Form 43 may be a scanned copy and sent electronically, or the original may be mailed. New requests may have an attached AFTO Form 186, *Nuclear Weapons Technical Order Publications Request*, requesting initial distribution. Once AFNWC/ NDET receives and approves the AFTO Form 43 and AFTO Form 186, the TOs will be distributed. When approved by AFNWC/ NDET, copies of the completed form will be provided electronically to the MAJCOM and TODO, to be maintained in their records.

10.5.2 Ordering TOs (AFTO Form 186). Orders will be submitted to AFNWC/ NDET, 2000 Wyoming Blvd SE, Kirtland AFB NM 87117-5617 using an AFTO Form 186, per Figure 10-1. Subscriptions for new TOs may be submitted as soon as the TO number appears in the Numerical Indexes. All TO orders must be justified. Submit orders and justification for TOs through the Approving Agency listed in Table 10-1. Orders and justification for unclassified TOs may be sent directly to AFNWC/ NDE. For questions regarding ordering TOs contact the AFNWC/NDE at DSN 263-3610, Comm (505) 853-3610.

10.5.2.1 When access to JNWPS data through DIAMONDS is desired, a minimum requirement of one must be submitted through the AFTO Form 186 process. This will establish the authorization to access the desired JNWPS data on DIAMONDS and also represents the number of copies the end user is authorized to print against their account. If the end user desires to print more copies than they are on requisition for, an AFTO 186 must be resubmitted to increase the authorized number of printed copies. For tracking and inventory purposes the AFNWC/ NDE will identify the type of distribution media for all JNWPS TOs with the following media-type suffix codes:

Code	Medium
DI	Access through DIAMONDS
CD	CD-ROM
None	Paper

For example the TO 0-1-11N Index will be listed as TO 0-1-11N-DI-1 if on distribution for it through DIAMONDS, TO 0-1-11N-CD-1 if on distribution for CD copies, and the paper copy would be listed as TO 0-1-11N. The TODO ID Listing and shipping labels will reflect each of these as applicable to the account. If on ID to receive multiple types of shipments of the same TO each type will be displayed separately on the TODO ID Listing as discussed above.

NOTE

Media-type suffixes appear only on the TODO ID Listing and on the mailing labels for tracking and inventory purposes. They are not placed on the TOs themselves. Once the actual TO is opened through any of these means it will only list the TO number without the media-type suffixes. Additionally, the TO 0-1-11N Index will not include media-type suffixes, however all three shipment types will include the same TO including revision and change, and can be checked for currency utilizing the TO 0-1-11N Index by looking up the applicable TO number excluding the media-type suffix code.

10.5.2.2 When using digital JNWPS data through DIAMONDS follow the guidance below for TO accountability.

10.5.2.2.1 TODO/TODA personnel and TO users are responsible for maintaining the currency of locally downloaded digital TO files whether kept electronically or in printed copy.

10.5.2.2.2 All AF Nuclear Weapon Center, Nuclear Related EOD, and JNWPS TOs will be entered into the TODO's ETIMS account as private books. The TODO will add TO notes for each book via the edit/need screen in ETIMS that the TO file is accessed digitally through DIAMONDS. ETIMS is used strictly as an inventory tool for Nuclear Weapon Center and Nuclear Related EOD TOs.

10.5.2.2.3 When the TODO re-hosts the digital TO file or reproduces and distributes the file locally, ETIMS records will reflect the redistribution quantities and sub accounts. ETIMS users must maintain a ETIMS record showing the various locations of the downloaded file in order to keep them updated. The ETIMS record may use a locally-derived TO number; for example "TO 00-5-1 (D1)."

10.5.3 Nuclear Weapons Center and EOD TO Approving Agencies. The following agencies (see Table 10-1) are responsible for monitoring and approving USAF or other U.S. government agency requests for classified TOs, assignment/change/cancellation of Nuclear Weapons and Nuclear EOD and Nonnuclear EOD TODO codes (AFTO Form 43) for Category 11N or 60N TOs, and approval of all contractor requests for TOs under their control. The TOMA identified in the index has the final authority for TO approval to the end user. Denied requests will be discussed with the TO approving agency before rejection. Agencies identified in Table 10-1 will identify personnel authorized to act as approving agents by furnishing AFNWC/ NDET with a letter listing the names, grades, titles, functional address symbols, telephone extensions, and representative signatures.

Table 10-1. Nuclear Weapons Center and EOD (Nuclear and NonNuclear Related) TO Approving Agencies

Nuclear Weapon TOs	EOD (Nuclear and Nonnuclear Related) TOs
SAF/IAPD	AFGSC/A7X
AFDW	AFDW/A4C
JFCC-GSI/J542	

Table 10-1. Nuclear Weapons Center and EOD (Nuclear and NonNuclear Related) TO Approving Agencies - Continued

Nuclear Weapon TOs	EOD (Nuclear and Nonnuclear Related) TOs
HQ USAF/A4LW	USAF/A4CXR
National Security Agency	National Security Agency
HQ USEUCOM/ECJ3	
AFNWC/ NDET (Nuclear)	AFNWC/ NDET (Nuclear)
ACC/A4W	AFIMSC Det 8/EOD (ACC & AFSOC)
AETC/A4MSW	AFIMSC Det 7/EOD (AETC)
AFMC/A4MW	AFIMSC Det 6/EOD (AFMC)
NGB/A4M	NGB/A7XF
AMC/A3N	AMC/A7XRD
PACAF/A4W	PACAF/A4-7ZS
USAFE/A3NM	USAFE/A7XED
AFGSC/A4BX	AFGSC/A7XE
ACO/PCO (contractors)	AFSOC/A7OX
AFSC/SEW	
AFRC/ A4M	AFRC/A4CE
Country validation agencies*	AFSPC/A7OX
AFNWC/ OLRAM/WS3	USAFCENT/A7XE
AFGSC/A3	
AFIA	
HQ AFSPC/A4S	

NOTE

Country validation agencies approve and coordinate establishment of Nuclear Weapon-TODOs. Prepare an AFTO Form 186 with required justification to order authorized nuclear TOs when the requesting government does not provide one.

10.5.4 Nuclear Weapons TCTOs. Nuclear weapon center TCTOs shall be managed IAW paragraph 7.5.1.

10.5.5 Annual Validation of Nuclear Weapons Center and Nuclear EOD TO Requirements. Every January, AFNWC/ NDET will provide all TODOs with a Technical Order Distribution Office Initial Distribution Listing (TODO ID Listing) for review. If no changes are required, the TODO signs and returns the cover letter to AFNWC/ NDET. If requirements change, complete and return cover letter and applicable change form(s) (AFTO Forms 43/186). Failure to meet account validation suspense date will result in account suspension until resolved.

10.5.6 Nuclear TODO Training. Nuclear TODO training is in addition to general AF TODO training. It is provided for nuclear TODOs to familiarize them with unique nuclear requirements. AFNWC/ NDET Home Office is responsible for this familiarization training. The training is a slide show that explains requirements identified in TO 00-5-1, Chapter 10. Access to this training is at the following website:

<https://cs1.eis.af.mil/sites/nmc2/AFMC/AFNWC/NDET/TODOTraining%20Supplement/Forms/AllItems.aspx>

10.6 NUCLEAR WEAPONS TECHNICAL ORDER PROCEDURES IN SUPPORT OF FOREIGN GOVERNMENTS.

TO support to foreign governments is provided according to AFMAN 23-110, *USAF Supply Manual*, AFI 16-1404, AFMAN 16-101, *Internal Affairs and Security Assistance Management*, and Allied Command Operations (ACO) Directive 80-6/European Command Directive 60-12. The following procedures implement those directives:

10.6.1 USAF Agency Actions for Nuclear Weapons TOs.

10.6.1.1 SAF/IAPD is the USAF disclosure authority for Nuclear Weapons TOs required by foreign countries. SAF/IAPD will furnish AFNWC/ NDET with a letter containing the names, grades, duty titles, office symbols, telephone extensions, and representative signatures of officials authorized to approve release of classified nuclear TOs to foreign governments. SAF/IAPD will submit a revised letter when changes occur.

10.6.1.2 AFNWC/ OLRAM/WS3, the European validation agency, will provide a letter to AFNWC/ NDET listing the names, grade, duty titles, office symbols, and telephone extensions of the individuals authorized to sign AFTO Forms 43 and 186.

10.6.2 Establishing a Nuclear Weapons-FMS-TODO (applies to Non-U.S. NATO organizations only). After verifying the host nation requirement for a new TO distribution account, AFNWC/ OLRAM/WS3 will prepare an AFTO Form 43 (electronic copies are acceptable) to establish a Nuclear Weapons-FMS-TODO and forward to AFNWC/ NDET for action. The AFTO Form 43 will be completed IAW procedures in Chapter 4 and the added procedures contained in Table 10-2 .

10.6.3 US Organizations Monitoring Loading of Special Weapons on Non-US Aircraft.

10.6.3.1 US organizations monitoring loading of special weapons on non-US aircraft may identify/mark steps impacting nuclear surety as determined by the AFMC Nuclear Weapons Center's Engineering Liaison Office. US load monitor checklists containing markings will only be used to verify nuclear surety and will not be used to perform actual loading operations.

10.6.3.2 When loading TO revisions/changes are received that are applicable to the host nation and the host nation is not yet in receipt, USAF TODOs/load monitors are exempt from the five day posting requirement and shall use existing tech data until the host nation receives updated tech data. Once the host nation receives updated tech data the five day posting requirement begins for USAF books. Revisions/changes involving nuclear surety/safety issues are not subject to this exemption.

Table 10-2. Instructions for Completing of AFTO Form 43 for Establishment of NW-FMS-TODO

Block	Instructions
Block 3 Block 4b	Complete address lines to indicating "Non-U.S. recipient (identify country and unit)" Enter "NW-FMS-TODO" in the Continuation block. On the back explain that the requested TODO will be used to provide releasable unclassified nuclear TOs to foreign national units or agencies. Provide enough information (that is, systems and equipment being used by the foreign unit or agency) to support release requests. If classified information must be used to justify requests, it will be submitted in a separate cover letter.
Block 4h	Enter "NW-FMS-TODO" in the Remarks block. On the back explain that the requested TODO will be used to provide releasable unclassified nuclear TOs to foreign national units or agencies. Provide enough information (that is, systems and equipment being used by the foreign unit or agency) to support release requests. If classified information must be used to justify requests, it will be submitted in a separate cover letter.
Block 6	This block will contain the signatures of AFNWC/ OLRAM/WS3 personnel responsibilities for the NW-FMS-TODO.
Block 7	Not used.
Block 8	Used by AFNWC/ OLRAM/WS3 to indicate the NW-FMS-TODO is approved.

10.6.4 Validating FMS Requirements and Requisitions for Nuclear Weapons TOs.

10.6.4.1 Validation will be IAW paragraph 10.5.5 and routed through the Country Validation Agency.

10.6.4.2 Non-U.S. Air Force agencies in Europe will forward AFTO Forms 186 through AFNWC/ OLRAM/WS3, Unit 8745, APO AE 09094-8745, for validation of both classified and unclassified additions/deletions.

TO 00-5-1

10.6.5 FMS Release Approval.

10.6.5.1 Ensures nuclear weapon system publications are properly sanitized for non-U.S. use in coordination with Foreign Disclosure Office and Joint Atomic Information Exchange Group (JAIEG) office controls release of unclassified nuclear weapon TOs to foreign countries when validated by AFNWC/NDEO.

10.6.5.2 After validation by AFNWC/NDEO and approval by JAIEG via FDO, AFNWC/NDET will distribute unclassified nuclear weapons TOs.

10.6.6 FMS Distribution. When directed by SAF/IAPD, the technical content manager will prepare a sanitized Nuclear Weapons TO and the TO Manager will arrange for distribution. In working with AFNWC/NDEO and the technical content manager in AFNWC.NDET will prepare a sanitized Nuclear Weapons TO and the TO Manager will arrange for distribution.

TECHNICAL ORDER PUBLICATIONS REQUEST								
1. TODO ACCOUNT ADDRESS <i>(Exactly as established with 708 NSS)</i>			3. I CERTIFY THAT THE REQUIREMENTS HEREIN ARE THE MINIMUM REQUIREMENTS TO SUPPORT THE MISSION OF ALL ORGANIZATIONS SERVED BY THIS DISTRIBUTION CODE. REQUIREMENTS ARE APPROVED IAW PROVISIONS OF TOs 00-5-1 AND SUPPLEMENTS THERETO.					
			TODO NAME, GRADE			TODO SIGNATURE		
2. NW TODO ACCOUNT NUMBER <i>(4 digit code)</i>			4. REQUESTS FOR SHIPMENT OF CLASSIFIED TOs OR INCREASING INITIAL DISTRIBUTION QUANTITY OF CLASSIFIED TOs REQUIRES THE APPROVING OFFICIAL/MAJCOM TO CERTIFY THE REQUESTING ACTIVITY HAS A VALID REQUIREMENT AND NEED TO KNOW FOR THE TOs					
			USAF/US GOVERNMENT/CONTRACTING APPROVING OFFICER <i>(Name/Grade)</i>			USAF/US GOVERNMENT APPROVING OFFICER		
			USAF ORGANIZATION <i>(Indicate MAJCOM)</i>					
LINE NUMBER	DATE REQUEST PREPARED	TODO REQUEST NUMBER <i>(For TODO Internal Use Only)</i>	TECHNICAL ORDER NUMBER	SECURITY CLASSIFICATION	INITIAL DISTRIBUTION QUANTITY <i>(Subscription Quantity)</i>	NUMBER OF COPIES REQUESTED	TYPE OF SHIPMENT <i>(For JNWPS TOs Only)</i>	JUSTIFICATION <i>(Applicable for all initial distribution quantity increases and/or all hard copy shipment requests)</i>
1								
2								
3								
4								
5								
6								
7								
8								
9								
10								

AFTO FORM 186, 20071217

Previous Editions are obsolete.

H0315338

Figure 10-1. AFTO Form 186, Nuclear Weapons Technical Order Publications Request

NOTE

Use the instructions listed in Table 10-3 to complete the AFTO Form 186 for nuclear weapon and nuclear related EOD TO orders. The AFTO Form 186 may be e-mailed to afnwc.ncl@us.af.mil, faxed (DSN 246-8911, Com: (505) 846-8911), or mailed to the AFNWC/ NDET.

Table 10-3. Instructions for Completing AFTO Form 186, Nuclear Weapons Technical Order Publications Request

Block	Instructions
Block 1 - TODO ACCOUNT ADDRESS	Enter TODO account address exactly as established with AFNWC/ NDET on the AFTO Form 43 (box 3) that was submitted to create/revise the account.
Block 2 - NW TODO ACCOUNT NUMBER	Enter NW TODO account number. This is the four-digit, all numeric number assigned to the account that is also listed on the AFTO Form 43 in the TODO/TM ACCOUNT CODE box.
Block 3 - TODO NAME, GRADE TODO SIGNATURE	Enter the name and grade of TODO submitting the form. The individual signing the form must be a TODO that is currently listed in box 6 of the AFTO Form 43. If sending electronically the TODO must digitally sign the form with their Common Access Card (CAC) by clicking the signature button, clicking the sign button, entering your CAC pin, and selecting the OK button.
Block 4 - USAF GOVERNMENT/CONTRACTING APPROVING OFFICER USAF ORGANIZATION USAF/GOVERNMENT/ CONTRACTING APPROVING OFFICER SIGNATURE	Block 4 must be forwarded to and signed by the USAF/US government officer (MAJCOM) or contracting approving officer (contractor accounts only) only when requesting shipment of classified TOs or increasing initial distribution quantity of classified TOs. Unclassified requests do not require a signature in this box and can be directly forwarded to the AFNWC/ NDET. Enter the MAJCOM the account falls under as listed in Table 10-1 Nuclear Weapons and EOD (Nuclear and Nonnuclear Related) TO Approving Agencies. If sending electronically the USAF/US government officer (MAJCOM) or contracting approving officer (contractor accounts only) must digitally sign the form with their CAC by clicking the signature button, clicking the sign button, entering your CAC pin, and selecting the OK button.
DATE REQUEST PREPARED	Enter the date the request is prepared, by clicking on the calendar button and then clicking the date, or by manually entering the date using the all-numeric yyyyymmdd format.
LINE NUMBER	The horizontal line number specifically describes information regarding the TO listed and is utilized to separate requests for different TOs.
TODO REQUEST NUMBER	This box is for TODO internal use only and can be used to track AFTO Form 186 submissions internally by the unit. Numbers, letters, or a combination of both can be utilized. TODO may choose to leave this box blank.
TECHNICAL ORDER NUMBER	Enter the applicable technical order number in this box.
SECURITY CLASSIFICATION	Enter the applicable security classification for the TO listed by clicking on the red arrow and then selecting the applicable classification. Classifications can be found in the TO 0-1-11N and TO 0-1-11N-1-CD-1 indexes.

Table 10-3. Instructions for Completing AFTO Form 186, Nuclear Weapons Technical Order Publications Request - Continued

Block	Instructions
INITIAL DISTRIBUTION QUANTITY	The Initial Distribution (ID) Quantity column is filled in for initial, increasing, decreasing or deletion of technical order quantities. Enter the total number of copies of the TO you would like to be on subscription for. This is the number of changes and revisions that will automatically be shipped to you. For TOs accessed through DIAMONDS, this number represents the number of TOs you are authorized to print out. To delete a TO from your account enter a "0" in this box. If you are not changing your ID quantity but only requesting shipment of the TO, you can leave this box blank.
NUMBER OF COPIES REQUESTED	Enter the number of copies of the TO you would like to be shipped to you. If the TODO is only going on subscription for a TO and is not requesting copies of the TO be shipped to them or if the TODO is requesting access through DIAMONDS, this box can be left blank.
TYPE OF SHIPMENT	This box is applicable to Joint Nuclear Weapon Publication System (JNWPS) TOs only . All JNWPS TOs are listed in the TO 0-1-11N index and will have a JNWPS usage warning on the title pages. Enter the type of shipment by clicking on the red arrow and selecting the applicable type of shipment you are requesting. To request shipment of multiple types of the TO, enter a separate line number entry for each type. When requesting Air Force Nuclear Weapon TOs (listed in the TO 0-1-11N-1-CD-1 index) leave this box blank.
JUSTIFICATION	<p>Enter an unclassified justification in this box for all initial distribution quantity increases and all shipment requests. For example: in support of contingency operations, expanded mission requirements, new organization with mission related taskings, etc.</p> <p style="text-align: center;">NOTE</p> <p>The justification box allows you to enter an unlimited amount of characters. If you fax or print out and mail the AFTO Form 186 only the first two lines of the form will be viewable. If you fax or mail the AFTO Form 186 ensure you limit your justification to the first two lines or attach the justification on a separate document.</p>

10.7 NONNUCLEAR EXPLOSIVE ORDNANCE DISPOSAL (EOD) CATEGORY 60 TECHNICAL ORDERS.

10.7.1 Establishing Nonnuclear EOD Technical Order Accounts. The AFTO Form 43 will be used to request assignment, change, or cancellation of nonnuclear EOD TODO accounts. The AFTO Form 43 will be completed in accordance with Chapter 4. The requesting office will forward the completed form to their MAJCOM functional manager (Table 10-1). The MAJCOM functional manager will forward the approved AFTO Form 43 to AFCEC/CXE for final approval. Disapproved forms will be returned to the initiator with appropriate justification. Upon receiving an approved AFTO Form 43, AFCEC/CXE will establish distribution for the account with NSWC IHEODTD and provide the MAJCOM and TODO copies of the approved AFTO Form 43 for their records.

10.7.2 Outside Agency Requests. Requests for nonnuclear EOD TOs by outside agencies/organizations must be sent via letter directly to the Commander, NSWC IHEODTD, 2008 Stump Neck Rd, Indian Head MD 20640-3681.

CHAPTER 11

TO SYSTEM TRAINING

11.1 GENERAL.

Training is a key part of a successful TO program. The focus of this chapter is to provide information on training resources available to TO users, TO Distribution Offices (TODO), TO Distribution Accounts (TODA), and TO Library Custodians to enable them to acquire the knowledge and skills necessary for success in completing or executing their TO duties.

11.2 TRAINING REQUIREMENTS.

All TO using organizations will ensure TODO and TODA personnel, as well as TO library custodians and TO users, are trained. This chapter and associated appendixes provide mandatory minimum requirements. Due to the varied status of individuals performing TO duties (for example, civilians, military, contractors), organizations are allowed to use locally developed forms or systems to track training accomplishment. To facilitate completion of this task, On-the-Job (OJT) training syllabuses have been created for select roles within the TO System. The syllabuses should be used as a guide when creating local training plans. It is recognized that TO training comes in many forms and from various sources. Accordingly, it's likely that the trainee will have prior knowledge of many of the key concepts outlined in the syllabuses and little to no additional training will be required in these areas. Timelines for completion of training are specified within the syllabuses and must be followed to ensure success.

11.2.1 All TODO Personnel. TODO personnel, including contractor TODOs, must be familiar with a broad range of TO topics. A variety of training resources and courses are available. Local units should use Appendix B as a guide when completing training. TODO personnel will complete and file or record completion of required courses (Appendix B.4.2).

11.2.1.1 Nuclear TODO personnel will complete training IAW paragraph 10.5.6.

11.2.2 TODA/Library Custodians. TODA personnel and library custodians must work closely with TODO personnel and TO users. While their duties are not as extensive as TODOs, they must still be familiar with a broad range of TO topics. Local units should use Appendix C as a guide when completing training. TODA personnel and Library Custodians will complete and file or record completion of required courses (Appendix C.4.2).

11.2.3 TO Users. TO users are as varied as the people working in and for the Air Force. As such, latitude is given to trainers to determine both need and depth of training required for their people. Training for the people who are expected to use Air Force TOs during the course of their jobs is often included in more formal technical training or as part of a structured OJT program. All previous sources of training should be considered when determining a trainee's additional needs. Appendix D is therefore provided as a guide to focus trainers and trainees on common topics relevant to TO users when completing training.

11.3 TECHNICAL ORDER SYSTEM EDUCATION AND TRAINING RESOURCES.

TO System process education and training includes two components: education about TO System policy and processes and web-based training on the TO System business practices used to accomplish TO system business.

APPENDIX A

GLOSSARY OF REFERENCES AND SUPPORTING INFORMATION

A.1 REFERENCED AND RELATED PUBLICATIONS.

Publication Number	Publication Title
DODD 5160.62	Single Manager Responsibility for Military EOD Technology and Training
DoDM 5200.01 Vol 1-4	DoD Information Security Program: Overview, Classification, and Declassification
DODD 5230.25	Withholding of Unclassified Technical Data from Public Disclosure
DOD 5400.7-R/AF Sup	DoD Freedom of Information Act (FOIA) Program
DOD 7000.14- R, V11A, Chpt 4	User Charges http://comptroller.defense.gov/fmr
DODI 5230.24	Distribution Statements on Technical Documents
AFI 11-215	USAF Flight Manuals Program
AFMAN 16-101	International Affairs and Security Assistance Management
AFI 16-1404	Air Force Information Security Program
AFI 20-118	Instructions for the Interservicing of Technical Manuals and Related Technology Program
AFI 21-101	Aircraft and Equipment Maintenance Management
AFI 21-103	Equipment Inventory, Status, and Utilization Reporting
AFPD 20-1/63-1	Integrated Life Cycle Management
AFI 32-9005	Real Property Accountability and Reporting
AFI 33-115	Air Force Information Technology (IT) Service Management
AFI 33-360	Publications and Forms Management
AFI 33-364	Records Disposition - Procedures and Responsibilities
AFI 38-402	Airmen Powered by Innovation
AFI 61-201	Management of Scientific and Technical Information (STINFO)
AFI 63-101/20-101	Integrated Life Cycle Management
TO 00-5-3	AF Technical Order Life Cycle Management
TO 00-5-15	Air Force Time Compliance Technical Order Process
TO 00-5-16	Software Managers Manual, USAF Automated Computer Program Identification Number System (ACPINS)
TO 00-5-18	USAF Technical Order Numbering Program
TO 00-5-19	Security Assistance Technical Order Program
TO 00-20-1	Aerospace Equipment Maintenance General Policies and Procedures
TO 00-20-2	Maintenance Data Documentation
TO 00-20-14	Air Force Metrology and Calibration Program
TO 00-25-107	Maintenance Assistance
TO 00-25-108	Communications-Electronics (C-E) Depot Support
TO 00-25-172	Ground Servicing of Aircraft and Static Grounding/Bonding
TO 00-25-195	AF Technical Order System Source, Maintenance, and Recoverability Coding of Air Force Weapons, Systems, and Equipments
TO 00-105E-9	Aerospace Emergency Rescue and Mishap Response Information (Emergency Services)
TO 0-1-11N	Numerical Index to Joint Nuclear Weapons Publications (Including Related Publications)
TO 0-1-11N-C	Numerical Index to Joint Nuclear Weapons Publications (Including Related Publications) (Air Force Supplement)

Publication Number	Publication Title
33K-1-100-1	Calibration Procedure for Maint Data Collection Codes and Calibration Measurement Summaries
TM-86-01	Air Force Technical Manual Contract Requirements (TMCR)
MIL-HDBK-9660	DoD Produced CD-ROM Products
MIL-DTL-7700	Detail Specification: Flight Manuals, Air Refueling Procedures, and Abbreviated Checklists
MIL-STD-38784	Standard Practice for Manuals, Technical: General Style and Format Requirements
MIL-PRF-32216	Evaluation of Commercial-of-the-Shelf (COTS) Manuals and Preparation of Supplemental Data
MIL-PRF-83495	On-Equipment Organizational Maintenance Manual Set
MIL-PRF-87929	Operation and Maintenance Instructions in Work Package Format

A.2 RELATED FORMS.

Form Number	Form Title
AFTO 22 *	Technical Manual Change Recommendation and Reply
AFTO 32 *	Technical Order Binder Label
AFTO 43 *	USAF TODO Assignment or Change Request
AFTO 45 *	Request for Calibration Responsibility Determination
AFTO 186 *	Nuclear Weapons Technical Order Publications Request
AF 310	Document Receipt and Destruction Certificate
AF 847	Recommendation for Change of Publication
DD 2345	Militarily Critical Technical Data Agreement
DD 2861	Cross-Reference
DD 2875	System Authorization Access Request (SAAR)

* = Authorized for Computer Generation (CG). Use the version on the e-publishing website unless otherwise noted.

A.3 LIST OF ACRONYMS.

A&AS	Advisory and Assistance Services
ACC	Air Combat Command
ACO	Administrative Contracting Officer
ACPINS	Automated CPIN System
ADRL	Automatic Distribution Requirements List (Navy)
AEODPS	Automated EOD Publications System (EOD TOs only)
AFCEC	Air Force Civil Engineering Center
AFI	Air Force Instruction
AFGSC	Air Force Global Strike Command
AFJI	Air Force Joint Instruction
AFKAG	Air Force Cryptographic Aid General
AFMAN	Air Force Manual
AFMC	Air Force Materiel Command
AFMETCAL	Air Force Metrology and Calibration (Program)
AFOSH	Air Force Occupational Safety and Health
AFPD	Air Force Policy Directive
AFRC	Air Force Reserve Command

AFRL	Air Force Research Laboratory
AFSC	Air Force Safety Center
AFSOC	Air Force Special Operations Command
AFSPC	Air Force Space Command
AFTO	Air Force Technical Order
AIA	Air Intelligence Agency
ALC	Air Logistics Complexes (AFMC): OC - Oklahoma City; OO - Ogden; WR - Warner Robins
AMC	Air Mobility Command
API	Airmen Powered by Innovation
ANG	Air National Guard
APD	Army Publishing Directorate
APO/FPO	Army Post Office/Fleet Post Office
ASCC	Air Standardization Coordinating Committee
ASL	Accounts, sub-accounts and libraries
ATA	Air Transport Association
CAC	Common Access Card
CBT	Computer Based Training
CCP	Command Control Point
CD-ROM	Compact Disk -Read-Only Memory
CDO	Controlling DoD Office
C-E	Communications-Electronics
CENTO	Central Treaty Organization
CG	Computer-Generated (forms)
CLS/CS	Contractor Logistics Support/Contractor Support
CMD	Commercial Mobile Device
CNWDI	Critical Nuclear Weapons Design Information
CO	Contracting Officer
COCO	Contractor Owned-Contractor Operated
COR	Contracting Officer Representative
COTS	Commercial Off-the-Shelf (Hardware, Software or Manuals)
CPIN	Computer Program Identification Number
CSTO	Country Standard TO
CTOM	Centralized Technical Order Management (Committee)
CUI	Controlled, Unclassified Information
DA	Department of the Army
DAAS	Defense Automatic Addressing System
DAF	Department of the Air Force
DDR	Data Discrepancy Report (ETIMS)
DIAMONDS	Defense Integration and Management of Nuclear Data Services
DISA	Defense Information Systems Agency
DLA	Defense Logistics Agency
DLIS	Defense Logistics Information Service
DoD	Department of Defense
DSN	Defense Switched Network

TO 00-5-1

DVD	Digital Versatile Disk
ECA	External Certificate Authority
EDD	Estimated Delivery Date
EF	Electronic Form
ELSG	Electronic Systems Group
EOD	Explosive Ordnance Disposal
ESC	Electronic Systems Center
ETIMS	Enhanced Technical Information Management System
eTool	Electronic Tool
eTO	Electronic TO
FAA	Federal Aviation Administration
FDO	Foreign Disclosure Office
FMM	Flight Manual Manager
FMP	Flight Manuals Program (AFI 11-215)
FMS	Foreign Military Sales
FOA	Field Operating Agency
FOIA	Freedom Of Information Act
FOUO	For Official Use Only
FSA	Functional Systems Administrator
GAA	Government Approving Activity
GCSS	Global Combat Support System
GOCO	Government-Owned, Contractor-Operated
IC	Interim Change
ID	Initial Distribution or Identification
IDEA	Innovative Development through Employee Awareness (Program)
IETM	Interactive Electronic Technical Manual
IOS	Interim Operational Supplement
IP	Internet Protocol
IPDF	Indexed Portable Document Format (Adobe™)
ISS	Interim Safety Supplement
ITCTO	Interim Time Compliance TO
ITO	Interim Technical Order
ITPS	Identifying Technical Publication Sheet
JEDMICS	Joint Engineering Data Management Information and Control System
JG	Job Guide
JNWPS	Joint Nuclear Weapons Publication System
LAN	Local Area Network
LEP	List of Effective Pages
LOA	Letter of Offer and Acceptance
LOAP	List Of Applicable Publications

MAJCOM	Major Command
MAPAD	Military Assistance Program Address Directory
MDS	Mission/Design/Series
MIL-DTL	Military Detail Specification
MIL - SPEC	Military Specification
MIL-STD	Military Standard
MIQ	Maximum Issue Quantity
MPTO	Methods and Procedures TO
NACI	National Agency Check and Inquiries
NASIC	National Air and Space Intelligence Center
NATEC	Naval Air Technical Data and Engineering Service Command
NATO	North Atlantic Treaty Organization
NAVAIR	Naval Air Systems Command
NSWC IHEODTD	Naval Surface Warfare Center Indian Head EOD Technology Division
NWC	Nuclear Weapons Center
O&M	Operation(s) and Maintenance
ODS	Ozone Depleting Substances
OPR	Office of Primary Responsibility
OS	Operational Supplement
PACAF	Pacific Air Force
PC	Personal Computer
PCO	Procuring Contracting Officer
PI	Product Improvement
PIM	Product Improvement Manager
PM	Program Manager
POC	Point of Contact
POD	Print on Demand
PSN	Publication Stock Number
PS&D	Plans, Scheduling and Documentation
PTO	Preliminary Technical Order
R&D	Research and Development
RAC	Rapid Action Change
RC	Recommended Change
RD	Restricted Data
RDS	Records Disposition Schedule
REMIS	Reliability and Maintainability Information System
SAF	Secretary of the Air Force
SAO	Security Assistance Organization
SAP	Security Assistance Program
SATODS	Security Assistance TO Data System
SCM	Supply Chain Manager (AFMC)
SIPTOs	Standard Installation Practices TOs

TO 00-5-1

SMR	Source, Maintenance,& Recoverability (Code)
SMTF	Simple Mail Transfer Protocol
SO	Satellite Office
SS	Safety Supplement
TCM	Technical Content Manager
TCTO	Time Compliance TO
TDY	Temporary Duty
TM	Technical Manual
TMCR	TM Contract Requirements (document)
TMSS	Technical Manual Specifications and Standards
TO	Technical Order
TOC	Table of Contents
TODA	TO Distribution Account
TODD	TO Distribution Office
TODPS	TO Distribution and Print Service
TOPS	TO Page Supplement
USAF	United States Air Force
USAFE	U.S. Air Forces in Europe
URL	Uniform Resources Locator (Internet address)
VSP	Verification Status Page
WAN	Wide Area Network
WP	Work Package
WUC	Work Unit Code

A.4 GLOSSARY.

A

ACCURACY	A publication is accurate if it is free of errors (correct procedural steps, in the correct order, parts data that match parts used, etc.).
ADEQUACY	A publication is adequate if it permits the intended users to perform tasks in accordance with the approved maintenance or operational concept (read and understand all materials to a level that results in successful task performance).
ADVISORY AND ASSISTANCE SERVICES (A&AS)	<p>Advisory and assistance services are provided under contract by nongovernmental sources to support or improve: organizational policy development; decision-making; AFI 63-124 management and administration; program and/or project management and administration; or Research and Development (R&D) activities. It can also mean the furnishing of professional advice or assistance rendered to improve the effectiveness of Federal management processes or procedures (including those of an engineering and technical nature). In rendering the foregoing services, outputs may take the form of information, advice, opinions, alternatives, analyses, evaluations, recommendations, training, and the day-to-day aid of support personnel needed for the successful performance of ongoing Federal operations. One of the three following definitional subdivisions applies to any A&AS:</p> <ol style="list-style-type: none">1. Management and professional support services2. Studies, analyses, and evaluations3. Engineering and technical services

AIR FORCE STANDARD TECHNICAL ORDER MANAGEMENT SYSTEM	The system(s) of record for managing all activities associated with the TO System. The current active systems include Enhanced Technical Information Management System (ETIMS), the DLA Document Services Technical Order Distribute& Print Services (TODPS) and Security Assistance Technical Order Distribution System (SATODS).
AIR FORCE TECHNICAL ORDER SYSTEM	The Air Force system for the acquisition, management, publication, filing and use of technical manuals.
AIR LOGISTICS COMPLEX	The AFMC component having responsibility for the sustainment phase of a system or commodity life cycle, including the related TOs. ALCs perform depot-level maintenance on assigned systems and commodities during sustainment. (Some Product Centers have assumed cradle-to-grave life-cycle management of specific weapon systems.)
ANNUAL CHECKS	TODOs and TODAs verify the TOs on subscription are still required and the subscription quantities are correct in ETIMS accounts. TODOs must annually review the information on their file copy of the AFTO Form 43 and submit to the address in Block 2 of the AFTO Form 43, see Note in Para 4-2. If there are no changes, TODO will annotate date of review in Block 10 of file copy and submit to Block 2 of the AFTO Form 43, see Note in Para 4-2. TO Library Custodians perform and document library inventories to ensure the TOs are complete and current.

B

BASELINE TO FILE	The official, published file for a digital TO. It consists of the basic TO file merged (posted) with any published change files.
BRIEF MANUALS	These manuals are twenty pages or less in length, do not require front matter (except abbreviated title), have chapters or sections that begin on left-or right-hand pages with no blank pages, contain more than one chapter or section on a page, have pages, paragraphs, illustrations and tables numbered consecutively throughout the manual with single Arabic numerals and contain the words "THE END" following text on the last page. Brief manuals are always revised, never changed.

C

CATEGORY	The TO number assigned to a family group of TOs such as Aircraft, Engine, or Test Equipment. See TO 00-5-18 for a list of categories.
CLASSIFICATION OR PROPOSED CLASSIFICATION	One or two alpha characters listed in the TO index to denote the proposed classification of an unpublished TO or the actual classification of a published TO.
COMMERCIAL MANUALS	Commercial Manuals fall into two broad categories, defined below: COMMERCIAL OFF-THE-SHELF (COTS) MANUALS - COTS manuals are those technical publications developed by vendors to support commercially available products, and include users manuals, parts lists, schematics, etc. Generally, COTS manuals do not require Verification. MILITARY COMMERCIAL MANUALS - These manuals are developed to commercial specifications (for example, ATA-100 for aircraft manuals) for support of systems and end items developed specifically for the military. When acquired for use by government personnel, these manuals must be verified just like Military Specification manuals.
COMMAND CONTROL POINT (CCP)	The MAJCOM office or delegated activity responsible for review of AFTO Form 22s on a designated system, end item or specialty area.

COMMODITY	A designated item, subsystem or system that is not identified as a weapon system. Commodities are grouped into Product Groups that possess similar characteristics and applications benefiting from similar developmental, acquisition, and logistics support management processes.
COMMON ACCESS CARD (CAC)	An identity card and associated password which enables identity management of individuals registered within the DoD Public Key Infrastructure.
CONFIGURATION MANAGED EQUIPMENT	Equipment that reflects the current configuration of military systems and/or end items currently in the Air Force operational inventory. This equipment requires the use of the latest TO information as listed in the appropriate ETIMS TO Catalog.
CONNECTED OPERATIONS	During connected operations, the eTool is connected to the network and eTOs are not stored on the eTool. For example, office environments, hospitals, etc. eTO content is accessed and viewed directly through ETIMS. Typically, an eTool in this scenario is a desktop PC. (See “Disconnected Operations”)
CONTRACTING OFFICER (CO)	The only individual authorized to direct and/or redirect the effort or in any way amend any of the terms of a contract, other than those instances specifically delegated to an Administrative Contracting Officer (ACO) or a Termination Contracting Officer (TCO) by a contract clause or in writing by the Procuring Contracting Officer (PCO). For purposes of this TO the “Contracting Officer” is the individual located at the issuing office, and may be abbreviated as “CO” or “PCO”. Any changes made by a contractor WITHOUT Contracting Officer authority is made at the contractor’s own risk.
Contracting Officer’s Representative (COR)	Individual, including a Contracting Officer’s Technical Representative (COTR), designated and authorized in writing by the CO to perform specific technical or administrative functions related to monitoring a contract. The COR has no authority to make any commitments or changes that affect price, quality, quantity, delivery, or other terms and conditions of the contract.
CONTROLLED UNCLASSIFIED INFORMATION (CUI)	Technical data and TOs, engineering data, and other information listed in DoDI 5230.24 and AFI 61-201 for Marking and Dissemination of Operations and Support Technical data, and assigned distribution codes “B” through “F”.
CONTROLLING DoD OFFICE	The DoD activity that sponsored the work that generated the technical data or received the technical data on behalf of the Department of Defense and, therefore, has the responsibility for determining the distribution of a document containing such technical data. For joint sponsorship, the controlling office is determined by advance agreement and may be either a party, group, or committee representing the interested activities or the DoD Components.
Primary Distribution	The initial targeted distribution of an access to technical documents authorized by the controlling DoD office.
Secondary Distribution	Release of technical documents provided after primary distribution by other than the originator or controlling office. It includes loaning, allowing the reading of, or releasing a document outright, in whole or in part.
COUNTRY VALIDATION	An office responsible for monitoring and validating foreign government requests for NW TOs. For European countries, OL-EL/ELO will act as the Country Validation Agency; all other foreign government requirements will be validated by the assigned Military Assistance Advisory Group (MAAG), Office of Defense Cooperation (ODC), U.S. Defense Attaché Office (USDAO) or similar activity.

D

DIGITAL TO	A digital TO file distributed either on physical media (e.g., CD/DVD) or via electronic means (i.e., eTO).
DISCONNECTED OPERATIONS	Disconnected operations satisfy the continuity of operations for all mission critical electronic TOs, in the event of network outages. In disconnected operations, the eTool is used to view eTOs while not connected to the network. eTO content must physically reside on each eTool to allow the eTool to be disconnected and taken to point where the eTO is needed. For example, mobilization, flight line maintenance, etc. Typically, an eTool in this scenario is a rugged laptop. Using eTools in the disconnected mode necessitates cabinets and the establishment/maintenance of a master/slave architecture within ETIMS. (See “Connected Operations”)

E

ELECTRONIC TECHNICAL ORDER (eTO)	A digital TO file available for distribution and viewing via electronic means. eTO files are identified by a media distribution code suffix of“-WA-n,” where “-1” indicates ETIMS distribution, and “-2” indicates distribution through other electronic means. TODO and TODA personnel manage access to eTOs by granting permission to use one or more ETIMS accounts, subaccounts or libraries to an individual or an eTool. (See “CONNECTED OPERATIONS” and “DISCONNECTED OPERATIONS”)
ELECTRONIC TOOL (eTOOL)	A category of Commercial Mobile Technology devices that includes fixed and deployable multi-user devices including storage cabinets and network switches, qualified to interoperate on AF networks using AF Standard Desktop Configuration (SDC) suite of applications to view electronic Technical Orders (eTO) information and exchange information with maintenance/logistics information systems. eTools are available for purchase using AFWay, the web-based AF system for purchasing Information Technology.
ENHANCED TECHNICAL INFORMATION MANAGEMENT SYSTEM (ETIMS)	The AF portal application which combines the ETIMS TO catalog, ordering and account management functions of ETIMS with an eTO content repository, paper TO print on demand service (TODPS) and an eTO viewer.
ENHANCED TECHNICAL INFORMATION MANAGEMENT SYSTEMS (ETIMS) TECHNICAL ORDER (TO) CATALOG	Lists all TOs that can be available for user’s libraries and is sometimes referred to as the Air Force (AF) Technical Order (TO) Catalog.
EOD-TODO	An activity authorized to submit requirements for and to receive nonnuclear (Category 60) EOD TOs.
ERRATA SHEETS	Cover sheets used to transmit TO pages either inadvertently omitted from or misprinted in distributed TO increments. The pages being sent out via errata sheet must NOT include any TO changes, no matter how minor. The errata sheets will list the pages included and the actions to be taken to post them to the affected TO.
ETIMS eTO	A digital TO in AF HTML or PDF format that is uploaded or distributed to and viewed using ETIMS. These eTOs are numbered with a “-WA-1” TO number suffix. Both AF HTML and PDF TO files are indexed as merged basics with the date of the latest TO increment.

TO 00-5-1

eTOOL ADMINISTRATOR	Individual with rights in ETIMS to register Master eTools, associate TO libraries and audit assigned Master eTool status.
eTOOL GROUP ADMINISTRATOR	Individuals with rights in ETIMS to transfer ownership of eTools within Base or MAJCOM dependent on level of privilege assigned.
EXTERNAL CERTIFICATE AUTHORITY (ECA)	Public Key Infrastructure certification authorities for DOD entities that are ineligible for registration into the DOD public key infrastructure and DoD business partners who require certificates.

F

FINAL DISPOSITION	A recommended change disposition of “Approved”, “Deferred”, “Duplicate” or “Disapproved”.
FLIGHT MANUAL MANAGER (FMM)	The individual responsible for managing the technical content of FMP publications. This includes initial acquisition and verification, maintenance, and periodic reviews.
FMP FLIGHT MANUAL PROGRAM	Contains policy and procedures unique to flight manuals.
FORMAL TO	Military Specification (MIL-SPEC)-developed TOs that have been sufficiently verified to make them usable for operation and maintenance, and which are in any acceptable format (physical or digital), and are available for distribution in the TO System. Until fully verified, the TOs must contain a verification status page, identifying those functions that have not been verified. Formal TOs include commercial manuals accepted for Air Force use and assigned a TO Number.
FORMAT	<p><i>n.</i> 1. The shape, size, binding, typeface, paper and general makeup or arrangement of a publication, as determined by military or commercial specifications and standards; 2. Digital files developed to a particular computer application, such as Microsoft Word, Adobe Portable Document Format (PDF), or Standard Generalized Markup Language (SGML); 3. Publication medium, such as paper versus digital.</p> <p><i>v.</i> To arrange a document or publication according to a specific format.</p>

G

(AIR FORCE) GLOBAL COMBAT SUPPORT SYSTEM	Air Force program which is integrating all combat support related Automated Information Systems in order to provide enhanced war-fighter support.
GLOBAL TODO ACCOUNT	The ETIMS global TODO account (F*192X) which contains subscriptions to a number of commonly used, public releasable TOs for users without a local TODO.
GOVERNMENT APPROVING AUTHORITY (GAA)	<p>(1) The activity command or maintenance/operations supervision personnel authorized to request establishment of a TO Distribution Office for a government TODO, including a GOCO TODO.</p> <p>(2) The Contracting Officer (CO) or delegated representative authorized to approve contractor TO requirements. Assigned representatives may include the Administrative Contracting Officer (ACO), Contracting Officer Representative (COR) or other on-site government Quality Assurance personnel.</p>

GOVERNMENT (DOD) CONTRACTOR A contractor working on a contract issued by a Government agency. A DoD contractor has a contract issued by a DoD component.

GOVERNMENT SUPPORT CONTRACTOR A generic term to describe contractor personnel who augment organic Government personnel and are considered to be a functional extension of the Government activity. Government support contractors operate at government locations using government equipment, networks and facilities and may be part of an Advisory and Assistance Services (A&AS) contract.

H

HEALTH HAZARDS PRECAUTION DATA When hazardous chemicals or adverse health factors in the environment cannot be eliminated, appropriate precautionary requirements shall be included in TOs according to MIL-STD-38784.

I

INITIAL DISTRIBUTION (ID) The first distribution of a TO increment to the established subscription list. ID is considered to be completed when the printed TO is placed into the postal service or other carrier.

INITIATOR The individual who identifies a discrepancy or deficiency in the TO System and prepares the documentation and recommended change for submission to the final approving authority.

INTEGRATED COMMODITIES Commodities which are so tied to a weapon system that separate management is not feasible.

INTERACTIVE ELECTRONIC TECHNICAL MANUAL An “information oriented” digital technical manual whose format and style are optimized for computer presentation. IETM organization facilitates easy user access to technical information while the display device provides interactive procedural guidance, navigational directions, and supplemental information. An IETM facilitates the interchange of maintenance manual information with logistic support data supplemental to maintenance, such as maintenance data collection, training documentation, supply interface and data presentation control.

INTERIM DISPOSITION A recommended change disposition of abeyance, advisement or other.

J

JOINT NUCLEAR WEAPONS PUBLICATIONS SYSTEM (JNWPS) TOs and TMs used to support nuclear weapons and nuclear-related support systems, indexed in TOs 0-1-11N and 0-1-11N-C

L

LEAD COMMAND The Air Force assigns responsibility for overall management of each system to a “lead command” to ensure that all requirements associated with every system receive comprehensive and equitable consideration. The lead command provides a primary input into the process of developing and maintaining a force structure with a balance of complimentary capabilities, and it establishes a basis for rational allocation of scarce resources among competing requirements. When only one command uses a weapon or equipment system, it is automatically assigned Lead Command. See AFPD 10-9 for aircraft systems and AFI 10-901 for communication and information systems assignments.

M

MAJOR COMMAND	The highest-level activity responsible for management, operation and command control of a military system or end item. As used in this TO, major command includes Field Operating Agencies (FOAs) and Direct Reporting Units (DRUs).
MASTER eTOOL	An eTool configured to receive eTO content directly from the ETIMS Repository. (See "Slave eTool")
MASTER HOST SITE	The Internet or WAN server location where the master eTO is hosted by the proponent (owning) organization.
MILITARY SPECIFICATION MANUALS	These are TMs and TOs developed according to Military Standards and Performance/Detail Specifications.
MWS Mobile Work Station	May include laptops, cabinets, computers, and handhelds.

N

Non-ETIMS eTO	Electronically accessed, distributed and used digital TOs which are not available in ETIMS. These eTOs will be numbered with a "-WA-2" TO number suffix to differentiate them from ETIMS eTOs with "-WA-1" suffixes. TODOs must independently establish access to these eTOs according to procedures provided by the TO Manager (check the TO Catalog Notes).
NUCLEAR WEAPONS	TOs, technical manuals (TMs) and related publications for support of the nuclear weapons program.
NW-TODO	An activity authorized to submit requirements for and to receive Category 11N and ICBM TOs. AFNWC/NDET assigns special codes to identify NW-TODOs, NW-EOD-TODOs, and NW-FMS-TODOs.
NW-EOD-TODO	An activity authorized to submit requirements for and to receive Nuclear related (Category 60N) EOD TOs.
NW-FMS-TODO	A USAF or other U.S. government activity authorized to submit foreign government requirements for Nuclear Weapons weapon TOs. This activity is authorized to receive unclassified Nuclear Weapons TOs and forward the TOs to the foreign government.

P

PRELIMINARY TECHNICAL ORDERS (PTOs)	PTOs are produced in limited quantities for Air Force personnel to review and approve the contents during acquisition, and for development of initial training packages (TO 00-5-3).
PRODUCT IMPROVEMENT MANAGER (PIM)	The individual or office at an activity responsible for the quality and continuous improvement of the activity operations and maintenance of assigned equipment (part of the Quality Assurance activity).
PROGRAM MANAGER (PM)	Designated individual with responsibility for and authority to accomplish program objectives for development, production, and sustainment to meet the user's operational needs.

R

RAPID ACTION CHANGES (RACs)	Emergency or Urgent TO Changes distributed electronically to correct safety hazards or prevent mission degradation and work stoppages. RACs are formatted like routine TO Changes using the digital TO file composition software to allow seamless merging with the basic TO file. If the RAC is not composed for seamless merging, regardless of presentation format (page- or non-page-oriented), the data must be directly accessible via hyperlink to and from the affected location in the TO.
RECLASSIFIED	Change of a TO security classification or proposed classification.
RELEASE APPROVING AGENCY FOR FOREIGN ACCOUNTS	The office authorized to approve release of NW data to foreign governments.
RENUMBER	Changing a TO number or TCTO series number to correct errors with the originally-assigned number.
REQUISITION	A request for distribution of published TOs.
RESCIND	A TO is rescinded when the TO Manager removes it from active status with no replacement. TOs are rescinded when the equipment they support leaves the active inventory, or when the TCTO rescission date has expired and the manager rescinds it. See also Supersede.

S

SHALL, WILL, SHOULD, MAY	In TOs the word “shall” is used to express a provision that is binding. “Will” may be used to express a mandatory declaration of purpose or when it is necessary to express a future event. The word “should” indicates a preferred method of accomplishment. The word “may” indicates an acceptable or suggested means of accomplishment.
SINGLE MANAGER (SM)	The generic term encompassing System Program Directors (SPD) and Product Group Managers (PGM) (see definitions). The individual responsible for management of all aspects of a system, product group or materiel group.
SLAVE eTOOL	An eTool that receives its eTO content via a “file share”, synchronization process with the cabinet Master eTool. (See also “Master eTool”)
SUBSCRIPTION	Defined as a requirement established by a TODO for a TO or a TCTO, to provide follow-on support (revisions, changes, and supplements) for established users. Subscriptions are established for unpublished TOs to help determine printing quantities and ensure distribution when the TO is published. The subscription requirement is retained in ETIMS until changed or deleted.
SUPERSEDE	Action taken to replace a TO update or an entire TO with a later version. TO revisions supersede (or replace) the basic or earlier revisions of the same TO, along with all related changes and supplements. Although not commonplace, one or more TOs can be superseded (replaced) by a totally different TO.
SUPPLEMENTAL DISTRIBUTION	Supplemental Distribution action is used to fulfill organizational requirements when only partial initial distribution was made due to insufficient stock.
SUPPLY CHAIN MANAGER (SCM)	Designated individual(s) at an ALC responsible for managing a line of National Stock Number (NSN)-coded items. SCM functions include requirements determination; cataloging, standardization and engineering data management; stock control and distribution; technical management functions; and pricing for assigned items. SCMs report to ALC commanders, but are responsible for supplying, repairing, and managing materiel to support SMs.

SYSTEM A discrete stand-alone collection of end items, components and related resources which, in conjunction with user support and operation, provides a capability to accomplish a specific mission.

T

TECHNICAL CONTENT MANAGER (TCM) The individual or office responsible for the accuracy, adequacy, modification, classification and review of TO procedures, engineering data and the related technical contents of a TO. TCMs are not generally responsible for style and format or other non-technical aspects of manuals.

TECHNICAL DATA Technical data is defined in public law as "...recorded information (regardless of the form or method of recording) of a scientific or technical nature (including software documentation) relating to supplies procured by an agency. Technical data does not include computer software or financial, administrative, cost or pricing, or management data or other information incidental to contract administration." This definition includes engineering data, source data and TO data (for example, schematic diagrams, flow diagrams, manufacturer handbooks, manuscripts of O&M instructions, PTOs commercial TMs, R&D TMs, and other system or equipment O&M procedures developed under AFMC or other acquisition agency directions during the system acquisition phase). Avoid use of this term when referring to specific types of data.

TECHNICAL MANUAL (TM) A document that contains operational or maintenance instructions, parts lists or parts breakdown, or other related technical information or procedures (exclusive of administrative procedures) for a weapon system, weapon system component, support equipment or other item procured by DoD. This data can be presented in any form (e.g. hard copy, audio and visual displays, magnetic tape, disks, or other electronic devices).

TECHNICAL ORDER (TM) ACCOUNT CODE ETIMS customer identification number established in order to transact business for automatic distribution of TOs available on physical media.

TECHNICAL MANUAL CONTRACT REQUIREMENT (TMCR) DOCUMENT The document approved for use by the Department of the Air Force to acquire TOs. It fully describes statement of work criteria for contractor program management, TO Quality Assurance, TO development and update, TCTOs, delivery instructions, and generic tailoring of the approved standards and specifications.

TECHNICAL ORDER (TO) TMs developed to MILSPECs or commercial manuals reviewed and approved in accordance with MIL-PRF-32216, managed in the Air Force TO System, and meeting the criteria for TMs listed above. The term Technical Order is equivalent to the DoD term Technical Manual.

TECHNICAL ORDER CATALOG A database providing information and current status of TOs currently active in the TO system. The catalog is used for management of TO libraries, developing requirements and preparing orders.

TECHNICAL ORDER DISTRIBUTION ACCOUNT (TODA) An authorized technical order distribution activity serviced by the TODO and assigned as a subaccount of the TODO.

TECHNICAL ORDER DISTRIBUTION OFFICE (TODO) The office or individual responsible for providing TO account administrative services for a unit or activity. These services will include consolidation and submission of subscription requirements and one-time requisitions for TOs/TO updates, receipt and distribution of TOs to unit or activity TO library custodians and oversight of TO library operations.

TECHNICAL ORDER DISTRIBUTION OFFICE CODE A number assigned to identify a nuclear weapon, nuclear-related EOD TODO or non-nuclear EOD TODO.

TECHNICAL ORDER FUNCTIONS	The standard set of functions consists of manage, acquire, improve, publish, stock, distribute and use TOs. These functions encompass the entire gamut of business practices and procedures from initial TO development or acquisition through final disposition.
TECHNICAL ORDER LIBRARY	One or more TOs maintained by individuals or offices for continuing use. Authorized TO libraries require distribution of all TO updates to ensure included TOs are current.
TECHNICAL ORDER LIBRARY CUSTODIAN	Individual designated and trained to maintain a physical media, technical order library.
TECHNICAL ORDER MANAGER	As used in this TO, refers to either the individual manager or agency responsible for managing the TO portion of a specific military system or end item program. TO Manager responsibilities include acquisition, update, publishing, storage and distribution of TOs and related technical data in accordance with AFPD 21-3 and 00-5-series TOs.
TOC TO	(ETIMS) Table of Contents Technical Order
TECHNICAL ORDER DISTRIBUTE AND PRINT SERVICES (TODPS)	TODPS is a Print on Demand concept of operation being implemented enterprise-wide in the Air Force to replace legacy stock, store and issue. TODPS requires the distribution and storage of digital TO files in the DLA Document Services central repository.

U

USER ORGANIZATION	An organization having a need for TOs.
USING COMMAND	The command that operates and/or maintains military systems or end items.

W

WARNING, CAUTIONS, AND NOTES	<p>Warning. Highlights an essential operating or maintenance procedure, practice, condition, statement, etc., which, if not strictly observed, could result in injury to, or death of, personnel or long term health hazards.</p> <p>Caution. Highlights an essential operating or maintenance procedure, practice, condition, statement, etc., which, if not strictly observed, could result in damage to, or destruction of, equipment or loss of mission effectiveness.</p> <p>Note. Highlights an essential operating or maintenance procedure, condition, or statement.</p> <p>In accordance with MIL-STD-38784, unless otherwise specified in the detail specification, warnings and cautions shall typically precede the text but follow applicable paragraph heading. Notes can precede or follow applicable text, depending upon the material to be highlighted. Warnings, cautions and notes shall not contain procedural steps, nor shall the headings be numbered. When a warning, caution or note consists or two or more paragraphs, the heading WARNING, CAUTION or NOTE shall not be repeated above each paragraph. Warnings and/or cautions and/or notes shall appear in this sequence. The paragraphs shall be short, concise and emphasize important and critical instructions.</p>
WEEKLY CHECKS	Currency checks performed weekly by TODOs/TODAs who manage downloaded, on-line, digital TO files, not associated with an ETIMS eTO subscriptions, since automatic notifications are not provided by ETIMS for such digital TO files.

APPENDIX B

ON-THE-JOB TRAINING SYLLABUS TECHNICAL ORDER DISTRIBUTION OFFICE (TODO)

COMPLETE WITHIN 90 DAYS (GOAL) OF ASSIGNMENT NOT TO EXCEED 180 DAYS

B.1 READING.

- AFPD 20-1/63-1, Acquisition and Sustainment Life Cycle Management
- AFI 61-201, Management of Scientific and Technical Information (STINFO)
- AFI 63-101/20-101, Integrated Life Cycle Management
- TO 00-5-1, AF Technical Order System (Include MAJCOM supplement if applicable.)
- TO 00-5-18, USAF Technical Order Numbering System, Chapter 1, paragraphs 1.1 through 1.9

B.2 TRAINING RESOURCES.

- AF e-Publishing web page via the AF Portal Home Page
- Air Force Technical Order Field Support Team (AFTOFST) AFNET site accessible at <https://cs3.eis.af.mil/sites/OOLG-TO-HP/default.aspx>
- AF Technical Order System Training AFNET site accessible at <https://cs3.eis.af.mil/sites/OO-TO-MC-35/default.aspx>

B.3 TRAINING REQUIREMENTS.

TODO General Course (IMDS Code 225001) and TODO Advanced Course (IMDS Code 225002), AF Technical Order System Training AFNET site (above), **REQUIRED**

NOTE

See IMDS and/or G081 Users manual for instructions on loading a new course code to your Unit ID.

B.4 TRAINEE FAMILIARIZATION.

B.4.1 TODO personnel must be familiar with key tech order policy and procedures documents in order to gain an understanding of the TO System. AFPD 20-1/63-1 provides the overarching policy for TO acquisition and use. AFI 63-101/20-101 outlines MAJCOM and program manager responsibilities for TO acquisition and sustainment. TO 00-5-1 is a core document for TODOs and provides policy and procedures necessary for sound account management. TO 00-5-18 provides procedures and insight into TO numbering practices.

B.4.2 TODO personnel must complete and file or record completion of the TODO General and TODO Advanced Courses (paragraph B.3), within 90 days of initial assignment.

NOTE

- Before beginning training, personnel should review the information on the AFTOFST AFNET site at <https://cs3.eis.af.mil/sites/OO-LG-TO-HP/default.aspx>.
- Unless directed by MAJCOM supplement, personnel who had previously completed the AETC On-line TO System courses need not complete the new TODO General and TODO Advanced Courses.
- Unless directed by MAJCOM supplement, personnel who had been trained exclusively via OJT while awaiting the release of the TODO General and TODO Advanced Courses need not complete the courses now that they are available.

B.4.3 TODO personnel must complete or have completed basic familiarization training on general TO user topics. Use Appendix D, Technical Order User, as a guide.

TO 00-5-1

B.4.4 TODO personnel should be familiar with key personnel available to them for help and assistance. This would include the Lead TODO (Chapter 4), Command TODO (when designated), and their Command representative on the AF Centralized Technical Order Management (CTOM) Committee (AFI 63-10). The AF CTOM roster is available at: (<https://cs3.eis.af.mil/sites/OO-EN-TO-PI/default.aspx>). When issues or questions arise TODOs should communicate with these people working from the Lead TODO up through the Command TODO and if necessary the CTOM representative if the issue concerns TO System policy or procedure improvements.

B.4.5 TODO personnel must be familiar with unit operations and mission requirements. This knowledge is needed to make informed decisions on unit TO requirements.

B.4.5.1 The Command TODO oversees the command technical order program and represents the field organizations relative to TO policy and procedures. They are the MAJCOM liaisons between the Air Logistics Complexes and HQ AFMC TO policy and procedures functional managers. A centralized technical order committee member charged with representing the field on major TO program matters or issues affecting the TO using community. The AF CTOM committee is a working level organization which makes formal recommendations to improve Air Force TO policy and procedures using a majority-voting system, with one vote per voting organization.

B.4.6 TODO personnel must be familiar with key concepts and duties described in TO 00-5-1 for their unit's TO requirements to include:

B.4.6.1 Types of TOs (Chapter 2).

- Operations and Maintenance (O&M)
- General
- Methods and Procedures TOs (MPTO)
- Index
- Abbreviated
- Brief Manuals
- Time Compliance Technical Orders (TCTO)
- Supplemental Manual
- Joint-Use
- Commercial
- Other authorized data

B.4.6.2 TODO functions (Chapter 4, TODO Functions).

- Review and discuss duties of Lead TODO
- ETIMS application, ETIMS ASLs, ETIMS Master eTools and eTool administration
- Review and discuss duties of all TODOs

B.4.6.3 Use of Technical Order Distribution Accounts (TODA) (Chapter 4).

B.4.6.4 Types of TO accounts as applicable (Chapter 4).

- Standard
- U.S. Contractor
- Security Assistance Program (SAP)
- Nuclear Weapons (NW)
- Nuclear Related Explosive Ordnance Disposal (EOD)
- EOD

B.4.6.5 Procedures for assigning, changing or updating a TO account (Chapter 4).

- AF Portal ID
- AFTO Form 43 completion
- Discuss F*/E*/D* account code usage
- Assignment of eTool administration rights for lead TODO

B.4.6.6 Types of authorized TO libraries as applicable (Chapter 5).

- Operational
- Aircraft Emergency Operating Instructions

- Aircraft
- Transient Aircraft
- Reference
- Training
- Contractor
- Rescinded Copies
- Reclamation Removal Work Package
- Work Package
- Creating ETIMS eTO libraries and assigning users
- Disconnected ETIMS eTO operations

B.4.6.7 Technical Order access controls (Chapter 5).

- Local digital dissemination of TOs
- eTool case marking

B.4.6.8 Contractor access to USAF Technical Order libraries (Chapter 5).

B.4.6.9 Procedures for filing TOs (Chapter 5).

- Use of a charge-out system
- Use of binders and labels
- Commercial and preliminary pubs
- Digital TOs
- Non-TO documents

B.4.6.10 Procedures for posting TOs (Chapter 5).

- Authorized updates
- Supersedure notices
- LEP checks
- Posting time limits
- Posting changes and revisions
- Posting and annotating supplements

B.4.6.11 Checking TO account distribution records and libraries (Chapter 5).

- Weekly checks, if applicable
- Annual checks
- LEP checks
- Use of TODO, TODA, Library Custodian checklist

B.4.6.12 Disposition of TOs and forms (Chapter 5).

B.4.6.13 Procedures for ordering TOs to include one-time requisitions and subscriptions (Chapter 6).

- Determining TO requirements
- Sponsor approval process
- Use of ETIMS
- Discuss difference between TO subscriptions and requisitions
- Emergency requisition procedures
- Contractor requirements, as applicable

B.4.6.14 Meaning and use of dissemination controls (Chapter 7).

- Review distribution statements (AFI 61-201)
- Discuss export control warning restrictions
- Discuss handling and destruction notice

TO 00-5-1

B.4.6.15 Actions required upon receipt of TOs (Chapter 7).

- Review packaging and shipping problem procedures
- Discuss how to handle shortage, excess or misdirected shipments
- Discuss how to handle classified TO shipments

B.4.6.16 Distribution of ITOs (Chapter 7).

B.4.6.17 Local reproduction of TOs (Chapter 7).

B.4.6.18 Special TODO procedures for nuclear weapons (NW), NW related EOD and nonnuclear EOD TOs as applicable Chapter 10).

B.4.6.19 General awareness of acronyms and terms used in the TO community (Appendix A).

APPENDIX C

ON-THE-JOB TRAINING SYLLABUS TECHNICAL ORDER DISTRIBUTION ACCOUNT (TODA) AND TECHNICAL ORDER LIBRARY CUSTODIAN COMPLETE WITHIN 90 DAYS (GOAL) OF ASSIGNMENT NOT TO EXCEED 180 DAYS

C.1 READING.

- AFPD 20-1/63-1, Acquisition and Sustainment Life Cycle Management
- AFI 61-201, Management of Scientific and Technical Information (STINFO)
- AFI 63-101/20-101, Integrated Life Cycle Management
- TO 00-5-1, AF Technical Order System (Include MAJCOM supplement if applicable.)
- TO 00-5-18, USAF Technical Order Numbering System, Chapter 1, paragraphs 1.1 through 1.9

C.2 TRAINING RESOURCES.

- AF e-Publishing web page, accessible via the AF Portal Home Page
- Air Force Technical Order Field Support Team (AFTOFST) AFNET site accessible at <https://cs3.eis.af.mil/sites/OO-LG-TO-HP/default.aspx>
- AF Technical Order System Training AFNET site accessible at <https://cs3.eis.af.mil/sites/OO-TO-MC-35/default.aspx>

C.3 TRAINING REQUIREMENTS.

- TODA / Library Custodian General Course (IMDS Code 225003), AF Technical Order System Training AFNET (above), **REQUIRED FOR ALL TODA PERSONNEL AND TO LIBRARY CUSTODIANS**
- TODA Advanced Course (IMDS Code 25004), AF Technical Order System Training AFNET (above), **ONLY REQUIRED FOR TODA PERSONNEL AUTHORIZED ETIMS SUB-ACCOUNT ACCESS BY THEIR TODO**

C.4 TRAINEE FAMILIARIZATION.

C.4.1 TODA personnel/library custodians must be familiar with key TO policy and procedures documents in order to gain an understanding of the TO System. AFPD 20-1/63-1 provides the over-arching policy for TO acquisition and use. AFI 63-101/20-101 outlines MAJCOM and program manager responsibilities for TO acquisition and sustainment. TO 00-5-1 is a core document for TODAs and provides policy and procedures necessary for sound account management. TO 00-5-18 provides procedures and insight into TO numbering practices.

C.4.2 TODA personnel and TO Library Custodians must complete and file or record completion of the TODA / Library Custodian General Course (paragraph C.3), within 90 days of initial assignment. TODA personnel authorized ETIMS sub-account access by their TODO must complete and file or record completion of the TODA Advanced Course (paragraph C.3), within 90 days of initial assignment.

NOTE

- Before beginning training, personnel should review the information on the AFTOFST AFNET site at <https://cs3.eis.af.mil/sites/OO-LG-TO-HP/default.aspx>.
- Unless directed by MAJCOM supplement, personnel who had previously completed the AETC On-line TO System courses need not complete the new courses (paragraph C.3).
- Unless directed by MAJCOM supplement, personnel who had been trained exclusively via OJT while awaiting the release of the new courses (paragraph C.3), need not complete the courses now that they are available.

C.4.3 TODA/Library Custodian personnel must complete or have completed basic familiarization training on general TO user topics. Use **Appendix D**, Technical Order User, as a guide.

C.4.4 TODA/Library Custodian personnel must be familiar with key concepts and duties described in TO 00-5-1 for their unit's TO requirements to include:

TO 00-5-1

C.4.4.1 Types of TOs (Chapter 2).

- Operations and Maintenance (O&M)
- General
- Methods and Procedures TOs (MPTO)
- Index
- Abbreviated
- Time Compliance Technical Orders (TCTO)
- Supplemental Manual
- Index TOs
- Joint-Use TOs
- Commercial Off-the-Shelf (COTS)
- Other authorized data

C.4.4.2 Review and discuss TODA/Library Custodian duties (Chapter 4, TODA Distribution Accounts/Library Custodians).

- AF Portal ID, ETIMS application, ETIMS ASLs, ETIMS Master eTool and eTool administration

C.4.4.3 Types of authorized TO libraries as applicable (Chapter 5).

- Operational
- Aircraft Emergency Operating Instructions
- Aircraft
- Transient Aircraft
- Reference
- Training
- Contractor
- Rescinded Copies
- Reclamation Removal Work Package
- Work Package
- Creating ETIMS eTO libraries and assigning users
- Disconnected ETIMS eTO operations

C.4.4.4 Technical Order access controls (Chapter 5).

- Local digital dissemination of TOs
- eTool case marking

C.4.4.5 Contractor access to USAF Technical Order libraries (Chapter 5).

C.4.4.6 Procedures for filing TOs (Chapter 5).

- Use of a charge-out system
- Use of binders and labels
- Commercial and preliminary pubs
- Digital TOs
- Non-TO documents

C.4.4.7 Procedures for posting TOs (Chapter 5).

- Authorized updates
- Supersedure notices
- LEP checks
- Posting time limits
- Posting changes and revisions
- Posting and annotating supplements

C.4.4.8 Checking TO account distribution records and libraries (Chapter 5).

- Weekly checks, if applicable
- Annual checks

- LEP checks
- Use of TODO, TODA, Library Custodian checklist

C.4.4.9 Disposition of TOs and forms (Chapter 5).

C.4.4.10 Procedures for ordering TOs to include one-time requisitions and subscriptions (Chapter 6).

- Determining requirements
- Sponsor approval process
- Use of ETIMS as applicable
- Discuss difference between TO subscriptions and requisitions
- Emergency requisition procedures
- Contractor requirements as applicable

C.4.4.11 Meaning and use of dissemination controls (Chapter 7).

- Review distribution statements (AFI 61-201)
- Discuss export control warning restrictions
- Discuss handling and destruction notice

C.4.4.12 Actions required upon receipt of TOs (Chapter 7).

- Review packaging and shipping problem procedures
- Discuss how to handle shortage, excess or misdirected shipments
- Discuss how to handle classified TO shipments

C.4.4.13 Use of local reproduction (Chapter 7).

C.4.4.14 Distribution of ITOs (Chapter 7).

C.4.4.15 Local reproduction of TOs (Chapter 7).

C.4.4.16 Discuss special requirements when working with nuclear weapons (NW), NW related EOD and nonnuclear EOD TOs as applicable (Chapter 10).

C.4.4.17 General awareness of acronyms and terms used in the TO community (Appendix A).

APPENDIX D

ON-THE-JOB TRAINING SYLLABUS TECHNICAL ORDER USER COMPLETE AS NEEDED

D.1 READING.

- AFPD 20-1/63-1, Acquisition and Sustainment Life Cycle Management
- AFI 61-201, Management of Scientific and Technical Information (STINFO)
- AFI 63-101/20-101, Integrated Life Cycle Management
- TO 00-5-1, AF Technical Order System (Include MAJCOM supplement if applicable.)
- TO 00-5-18, USAF Technical Order Numbering System, Chapter 1, paragraphs 1.1 through 1.9

D.2 TRAINING RESOURCES.

- AF e-Publishing web page, <http://www.e-publishing.af.mil/>
- Air Force Technical Order Field Support Team AFNET site accessible at <https://cs3.eis.af.mil/sites/OO-LG-TO-HP/default.aspx>
- AF Technical Order System Training AFNET site accessible at <https://cs3.eis.af.mil/sites/OO-TO-MC-35/default.aspx>

D.3 TRAINING REQUIREMENTS.

None.

D.4 TRAINEE FAMILIARIZATION.

D.4.1 TO users must be familiar with key TO policy and procedures documents in order to gain an understanding of the TO System. AFPD 20-1/63-1 provides the over-arching policy for TO acquisition and use. AFI 63-101/20-101 outlines MAJCOM and program manager responsibilities for TO acquisition and sustainment. TO 00-5-1 is a core document for TODAs and provides policy and procedures necessary for sound account management. TO 00-5-18 provides procedures and insight into TO numbering practices.

D.4.2 All TO users should be familiar with ETIMS as they will use ETIMS to view eTOs in ETIMS eTO libraries.

D.4.3 TO users should be introduced to key TO management personnel within their organization to include TODO/TODA/Library Custodian personnel as applicable. The various roles of these personnel should be explained and what the TO user's interaction is with these individuals.

D.4.4 TO users must be familiar with key concepts and processes described in TO 00-5-1 to include:

D.4.4.1 Air Force Technical Order Use (Chapter 1).

- MAJCOM and base supplements, if applicable
- Local tech data
- Write-in changes

D.4.4.2 Types of TOs (Chapter 2).

- Operations and Maintenance (O&M)
- General
- Methods and Procedures TOs (MPTO)
- Index
- Abbreviated
- Brief Manuals
- Time Compliance Technical Orders (TCTO)
- Supplemental Manual
- Joint-Use TOs
- Commercial

TO 00-5-1

D.4.4.3 Authorized support data (Chapter 2).

- Preliminary Technical Orders (PTO)
- Contractor data
- Engineering drawings
- Locally prepared workcards, checklists, job guides and page supplements

D.4.4.4 Types of TO updates (Chapter 2).

- Revisions
- Changes
- Supplements

D.4.4.5 Air Force TO Catalog (Chapter 3).

D.4.4.6 ETIMS Global TODO Account (paragraph 4.1.4).

D.4.4.7 Types of authorized TO libraries as applicable (Chapter 5).

- Operational
- Aircraft Emergency Operations Instructions
- Aircraft
- Transient Aircraft
- Reference
- Training
- Contractor
- Rescinded Copies
- Reclamation Removal Work Package
- Work Package

D.4.4.8 Meaning and use of dissemination controls (Chapter 7).

- Review distribution statements (AFI 61-201)
- Discuss export control warning restrictions
- Discuss handling and destruction notice
- Discuss safeguarding of classified TOs if applicable

D.4.4.9 Recommending changes (RC) to TOs (Chapter 9).

- Discuss reasons for submitting RCs
- Explain change types - improvement vs correction
- Explain priority categories - routine, urgent, emergency
- Discuss how to submit RCs
- Discuss local procedures currently in use for AFTO Form submissions as applicable
- Review disposition definitions - approved, deferred, abeyance, advisement, duplicate, disapproved, other
- Discuss follow-up procedures
- Discuss API program as it relates to RCs

APPENDIX E

DISTRIBUTION STATEMENTS AND CORRESPONDING REASONS FOR USE

E.1 DISTRIBUTION STATEMENTS.

NOTE

Extracted from Department of Defense Instruction (DoDI) 5230.24, Distribution Statements on Technical Documents. This DoDI 5230.24 reissues DoD Directive (DoDD) 5230.24. Pertinent information has been extracted from AFI 61-201.

E.1.1 DISTRIBUTION A. Approved for public release: distribution unlimited.

E.1.2 DISTRIBUTION B. Distribution authorized to U.S. Government agencies only (reason) (date of determination). Refer other requests for this document to (controlling or originating DoD office).

E.1.3 DISTRIBUTION C. Distribution authorized to U.S. Government agencies and their contractors (reason) (date of determination). Refer other requests for this document to (controlling or originating DoD office).

E.1.4 DISTRIBUTION D. Distribution authorized to Department of Defense and U.S. DoD contractors only (reason) (date of determination). Refer other requests for this document to (controlling or originating DoD office).

E.1.5 DISTRIBUTION E. Distribution authorized to DoD components only (reason) (date of determination). Refer other requests for this document to (controlling or originating DoD office).

E.1.6 DISTRIBUTION F. Further dissemination only as directed by (controlling or originating DoD office) (date of determination) or DoD higher authority (list the specific authority—unless a classified document). Distribution Statement F is normally used only on classified technical documents, but may be used on unclassified technical documents when specific authority exists (e.g., designation as direct military support as in Statement E).

NOTE

Distribution Statement F is normally used only on classified technical documents, but may be used on unclassified technical documents when specific authority exists.

E.1.7 DISTRIBUTION X. Distribution “X” is superseded by issuance of DoDI 5230.24. Subsequent dissemination of formerly Distribution X documents shall display Distribution Statement C, with export control as the reason.

E.1.8 EXPORT CONTROL WARNING. All printed and electronic, including digital, technical documents that are determined to contain export-controlled technical data shall be marked as shown in Figure 1. When it is technically infeasible to use the entire statement, an abbreviated marking may be used, and a copy of the full statement added to the “Notice To Accompany Release of Export-Controlled Data”.

WARNING - This document contains technical data whose export is restricted by the Arms Export Control Act (Title 22, U.S.C., Sec 2751, et seq.) or the Export Administration Act of 1979 (Title 50, U.S.C., App. 2401 et seq.), as amended. Violations of these export laws are subject to severe criminal penalties. Disseminate in accordance with provisions of DoD Directive 5230.25.

H1402841

Figure E-1. Export Control Warning Label

E.2 REASON STATEMENTS.

REASON STATEMENTS	A	B	C	D	E
PUBLIC RELEASE (Approval required by Public Affairs Office)	X				
ADMINISTRATIVE OR OPERATIONAL USE: To protect technical or operational data or information from automatic dissemination under the international exchange program or by other means. This protection covers publications required solely for official use or strictly for administrative or operational purposes. This statement may be applied to manuals, pamphlets, technical orders, technical reports, and other publications containing valuable technical or operational data.		X	X	X	X
CONTRACTOR PERFORMANCE EVALUATION: To protect information in management reviews, records of contractor performance evaluation, or other advisory documents evaluating programs of contractors.		X			X
CRITICAL TECHNOLOGY: To protect information and technical data that advance current technology or describe new technology in an area of significant or potentially significant military application or that relate to a specific military deficiency of a potential adversary. Information of this type may be classified or unclassified.		X	X	X	X
DIRECT MILITARY SUPPORT: The document contains export-controlled technical data of such military significance that release for purposes other than direct support of DoD-approved activities may jeopardize an important technological or operational military advantage of the United States, another country, or a joint U.S.-foreign program. Designation of such data is made by competent authority in accordance with Reference (d).					X
FOREIGN GOVERNMENT INFORMATION: To protect and limit distribution in accordance with the desires of and agreements with the foreign government that furnished the technical information.		X	X	X	X
OPERATIONS SECURITY: To protect information and technical data that may be observed by adversary intelligence systems and determining what indicators hostile intelligence systems may obtain that could be interpreted or pieced together to derive critical information in time to be useful to adversaries.		X			X
PREMATURE DISSEMINATION: To protect patentable information on systems or processes in the development or concept stage from premature dissemination.		X			X
PROPRIETARY INFORMATION: To protect information not owned by the U.S. Government and marked with a statement of a legal property right. This information is received with the understanding that it will not be routinely transmitted outside the U.S. Government.		X			X
TEST AND EVALUATION: To protect results of test and evaluation of commercial products or military hardware when disclosure may cause unfair advantage or disadvantage to the manufacturer of the product.		X			X
SOFTWARE DOCUMENTATION: To protect technical data relating to computer software that is releasable only in accordance with the software license in subpart 227.72 of Reference (s). It includes documentation such as user or owner manuals, installation instructions, operating instructions, and other information that explains the capabilities of or provides instructions for using or maintaining computer software.		X	X	X	X
SPECIFIC AUTHORITY: To protect information not specifically included in the above reasons, but which requires protection in accordance with valid documented authority (e.g., Executive orders, statutes such as Atomic Energy Federal regulation). When filling in the reason, cite“Specific Authority (identification of valid documented authority).”		X	X	X	X

REASON STATEMENTS	A	B	C	D	E
VULNERABILITY INFORMATION: To protect information and technical data that provides insight into vulnerabilities of U.S. critical infrastructure, including DoD warfighting infrastructure, vital to National Security that are otherwise not publicly available.		X	X	X	X

